

FEDERATION CYNOLOGIQUE INTERNATIONALE (AISBL)

Place Albert 1^{er}, 13 – B – 6530 Thuin, tel : +32.71.59.12.38, internet : <http://www.fci.be>

AGILITY JUDGING GUIDELINES



April 1st, 2021

TABLE OF CONTENTS

| | |
|--|----|
| 1. Introduction | 3 |
| 2. General principles for judges | 4 |
| 3. Judging ethics | 4 |
| 4. Appearance and conduct | 4 |
| 5. Personal items | 5 |
| 6. Preparing the competition | 5 |
| 7. Briefing the stewards and helpers | 5 |
| 7.1 Scribe | 5 |
| 7.2 Show secretariat (scorer) | 6 |
| 7.3 Collecting ring steward | 6 |
| 7.4 Time keeper | 6 |
| 7.5 Ring steward/helpers | 6 |
| 8. Briefing the competitors | 6 |
| 9. Course design | 7 |
| 10. Course building | 14 |
| 11. Standard Course Time and Maximum Course Time | 15 |
| 12. Judging | 16 |
| 13. Judging specific obstacles | 16 |
| 13.1 Hurdle | 16 |
| 13.2 Contact obstacles | 17 |
| 13.3 Long jump | 17 |
| 13.4 Weave poles | 18 |
| 14. Judging situations | 18 |
| 14.1 Refusals and subsequent marking | 18 |
| 14.2 Contacts, refusals and faults | 27 |
| 14.3 Judging a flyer on the see-saw | 29 |
| 14.4 Second judge at the upside of the dog-walk | 30 |
| 15. Other | 31 |
| 15.1 Eliminations | 31 |
| 15.2 Refusals | 31 |
| 15.3 Start sequence | 31 |
| 15.4 Re-run | 31 |

1. Introduction

These "Judging Guidelines" are meant to help judges in FCI member countries to come to the same understanding/interpretation of the rules.

The Guidelines do not intend to change existing rules or to be in contradiction with them, but they should help to clarify the gaps in interpretation left by the wording and/or drawings in the rules. The application of these Guidelines is compulsory at FCI events such as the World Championships, the European Open, the Junior Agility European Open and **FCI-CACI**Ag competitions.

The English text of these Guidelines in the latest version is always the reference one. Different interpretations can be caused by the translation into different languages.

The Guidelines are compiled in such a way that new proposals can always be added on. They are reviewed in 2.5-year intervals: one linked to the 5-year reviews of the FCI Agility Rules, and one intermediate review. Proposals should be sent in according to the time schedule confirmed by the FCI Agility Committee. The latest version of the Guidelines should always be used.

Time schedule

| | 2020 | 2021 | 2022 | 2023 | 2024 | 2025 | 2026 |
|----------------------------------|-------------|------------|------------------------------|------------|------------|----------|-------------|
| Rules valid | | | | 01.01.2023 | | | |
| Discussion/Decisions | | | February | | | | |
| Proposals | | 01.07.2021 | | | | | 01.07.2021 |
| Working group meeting | | November | April | | | | November |
| | 2020 | 2021 | 2022 | 2023 | 2024 | 2025 | 2026 |
| Judging guidelines valid | 01.07.2020 | | | 01.07.2023 | | | 01.07.2026 |
| Discussion/Decisions | February | | September/ October | | | | February |
| Proposals | | | 01.05.2022 | | 01.09.2024 | | |
| Working group meeting | | | Day before FCI-AWC | | | November | |
| | 2020 | 2021 | 2022 | 2023 | 2024 | 2025 | 2026 |
| Obstacle guidelines valid | 01.07.2020 | | | 01.07.2023 | | | 01.07.2026 |
| Discussion/Decisions | February | | September/ October | | | | February |
| Proposals | | | 01.05.2022 | | 01.09.2024 | | |
| Working group meeting | | | Day before FCI-AWC | | | November | |
| | 2020 | 2021 | 2022 | 2023 | 2024 | 2025 | 2026 |
| International judges' workshop | July/August | | | November | | | July/August |

It is recommended that FCI member countries apply the Judging Guidelines and implement these recommendations

in national agility events.

2. General principles for judges

An agility judge should always take into account that agility should be fun for the dog, the handler and the spectators.

An agility judge should be able to design a course with the correct level of difficulty.

An agility judge should have worked a dog himself so he can appreciate what it is like to be an agility competitor.

An agility judge should always be fair and just. Personal feelings should not interfere with his decisions.

An agility judge should be unwavering, confident and courteous.

An agility judge should be able to make quick and reliable decisions.

An agility judge should be capable of adjusting his course design at a moment's notice, for example due to the weather conditions or the condition of the floor surface.

An agility judge should be fit enough to judge all dogs the same.

3. Judging ethics

While officiating the judge is strict but fair and always courteous.

The judge should be competent, act impartially and without theatrics.

The judge should not try to pick fault in every detail and where there is doubt, the benefit should be given to the dog and handler.

An agility judge should judge all the competitors the same way.

The judge should always concentrate and make his decisions without any hesitation. ***If a judge wants to change a decision, he must do so before the next dog starts.***

The judge keeps strictly to the Rules and Regulations.

A judge should not get into a conversation with a competitor in the ring. If need be, he can briefly tell a handler why he has been eliminated.

The judge may only discuss his decisions or course design with the competitors when he has finished judging.

A judge does not criticise decisions and behaviour of a colleague openly but tries to speak to him privately.

A judge is always aware that he should lead by example, even when he is not officiating.

4. Appearance and conduct

An agility judge should wear suitable attire, which distinguishes him from the competitors.

The judge should not wear anything displaying his connection to clubs, competitors or sponsors.

An agility judge should always conduct himself properly and behave as a worthy agility representative.

An agility judge must indicate faults and refusals with hand signals. The arm should be clearly raised above the head. The start signal and eliminations should be signalled clearly so that neither the handlers nor the spectators are in doubt about the decision. An agility judge should not get into discussions with competitors or spectators about any judging decision.

5. Personal items

It is advisable for an agility judge to have the following items with him:

- Signature stamp
- Course drawings
- Whistle (2 – one as a replacement)
- Measuring wheel
- Rules and regulations that apply in the country where the show is held
- Measuring tape
- **Equipment to measure dogs**

6. Preparing the competition

The agility judge should communicate with the show representative to ascertain the following:

- Which rules and guidelines apply.
- Layout and size of the ring in which the competition is going to be held.
- The location of the show secretariat and where they are expecting the majority of the spectators to be (perhaps even a stand).
- A list of the available obstacles and confirmation that all the obstacles comply with the rules.
- Which categories and classes are to be judged and how many competitors he has to judge in each class.
- How many people will be helping in the ring.
- Timetable.
- Whether timekeeping is manual or electronic.
- Whether start and finish are separate, and where on the ring they are located.
- Whether copies of the course plans should be made available by the judge. A course plan should only be given to the helpers half an hour (maximum) before course building starts.

7. Briefing the stewards and helpers

The stewards and helpers should be fully briefed as to what is required of them. The briefing can be less elaborate or even left up to the organisation if the organisers and helpers are experienced.

Important: The scribe and the timekeeper cannot be replaced until the class is finished.

The ring stewards/helpers and show officials should be briefed about the following:

7.1 Scribe

- How the judge will indicate faults, refusals and eliminations.
- How a judging slip/sheet should be filled in.
- That he should always watch the judge, never the dog, and continue to watch until the judge stops judging the dog.
- Where the judge will be positioned on the course during the runs.
- Where the scribe should be positioned so he can always see the judge – move if necessary.
- How he will indicate to the judge that there have been three refusals.

7.2 Show secretariat (scorer)

- That the agility judge will check the scoring during the competition.
- That judging slips should be kept in the running order.
- That the judge must be informed immediately should a problem arise.

7.3 Collecting ring steward

- That he is responsible for ensuring that the running order is respected.
- That there should always be 3 to 5 dogs and handlers near the start.
- That he should indicate non-starters on his list next to the names of the competitors.
- The judge will explain precisely when he wants the next dog and handler to enter the ring.

7.4 Time keeper

- Explain when the time should be started and stopped.
- Explain that the time should start when the dog:
 - jumps the first hurdle
 - goes underneath the first hurdle
 - passes the start line of the first hurdle on the left or the right side
- That the time is never stopped before the dog has crossed the finish line (except when the dog has been eliminated).
- The time is stopped when the dog negotiates the last hurdle in the correct direction. This means that the dog jumps from the correct side (no matter if the pole is knocked down – fault!). The course is not yet finished and the time must not be stopped when the dog goes underneath the last hurdle or passes it on the left or the right side.
- That the time given to the scribe should always be to the 1/100th of a second.
- That he can release the dog from the start line after the judge's signal.
- That it should be signalled clearly when a dog exceeds the Maximum Course Time.
- That the time must be taken from the same positions at the start and the finish for each dog.
- That he should only reset the stopwatch after he's made sure that the scribe has noted the time (show the scribe the watch so he can copy the time down on the judging slip/sheet).
- That the manual time is used when the electronic time fails.

7.5 Ring steward/helpers

- That the collapsible tunnel should be straightened and the collapsible tyre checked after each dog has run.
- That the assigned obstacles are checked so they are exactly the same for each dog.
- That the height of the jumps is the same for each dog.
- That they cannot give up their allocated assignment before the class is finished.
- That the contacts or even the surface should be cleaned at regular intervals if circumstances require it (running on dirt for instance).

8. Briefing the competitors

If the judge wants to brief the competitors, then he should:

- Ascertain if any translation is necessary.
- Tell the handlers what the length of the course is and how the Course Time is defined.
- Indicate how the start signal will be given.

- Indicate how faults, refusals and eliminations will be indicated and what happens after an elimination.
- Remind handlers that they should continue their run unless the judge tells them to stop.
- **Remind handlers about any designated area (if available) where the dog can be rewarded after the run has been completed.**

9. Course design

A) The course plan should be drawn to scale and must be available, possibly with copies, on the day of the competition.

B) A judge is advised to use as many types of obstacles as possible.

C) The minimum distance on the dog's path between consecutive obstacles is 5m (4m in Small). The maximum straight-line distance between consecutive obstacles is 7m.

Both distances should be measured from the nominal point that the dog leaves the obstacle to the nominal point that the dog arrives at the next obstacle. For hurdles, these are the centres of the bars. For a tunnel, zone, slalom, etc., it is the nominal entry/exit points of those obstacles.

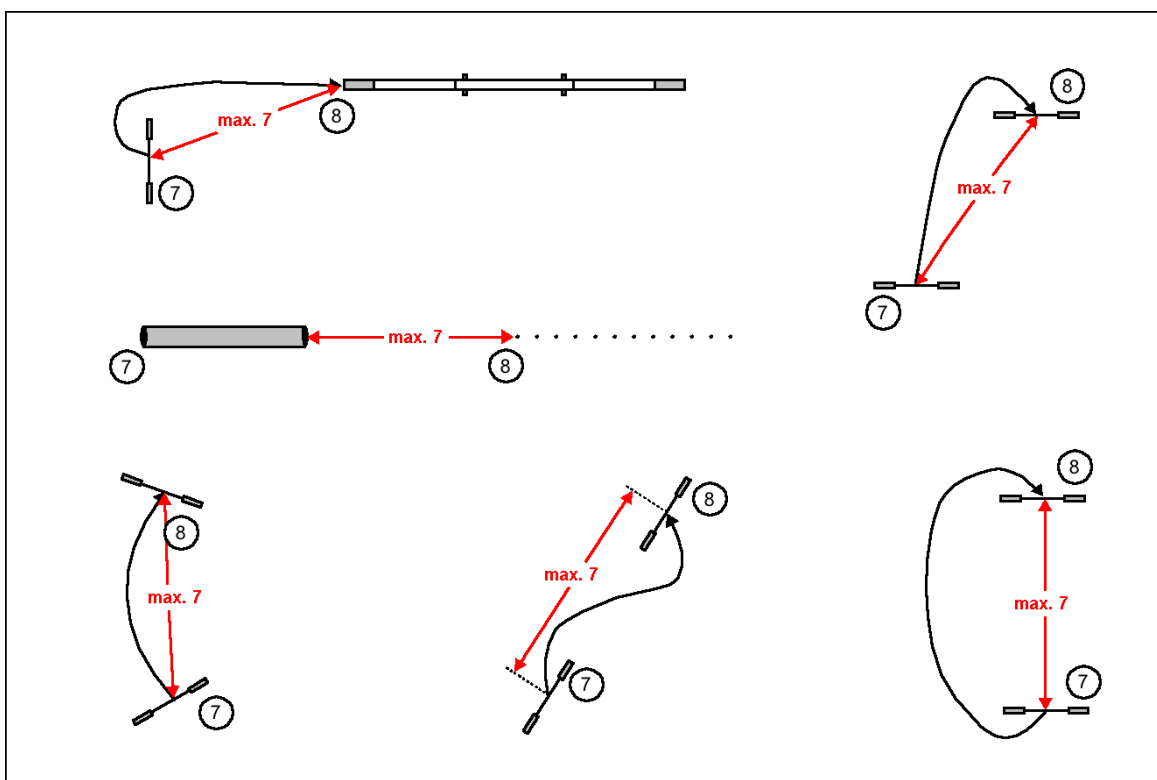

The minimum distance should be measured along the line most dogs will take, not the line the judge would prefer the dogs to take in order to keep it according to the rules.

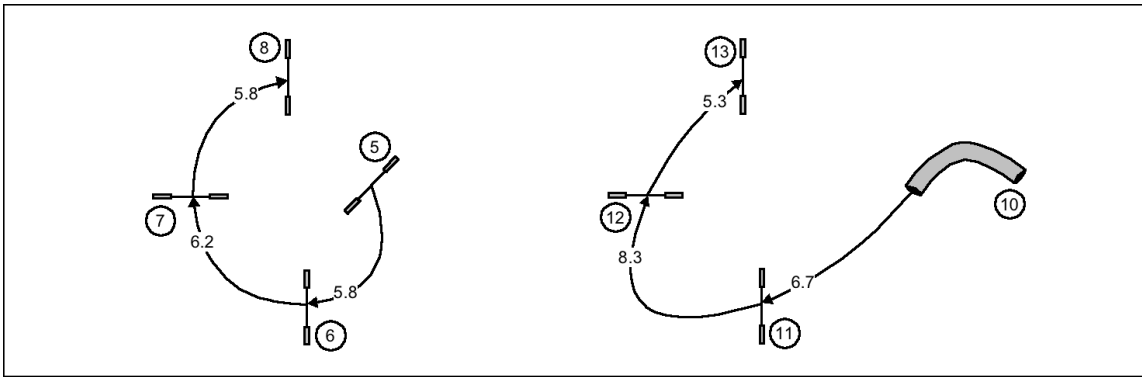

The sequence 6-7-8 is exactly the same as sequence 11-12-13, but because of another approach to number 11 and the speed of the dog being higher, the distance between 6-7 and 11-12 is not the same. The difference in speed and approach changes the line of the dog by about two meters between 6-7 and 11-12.

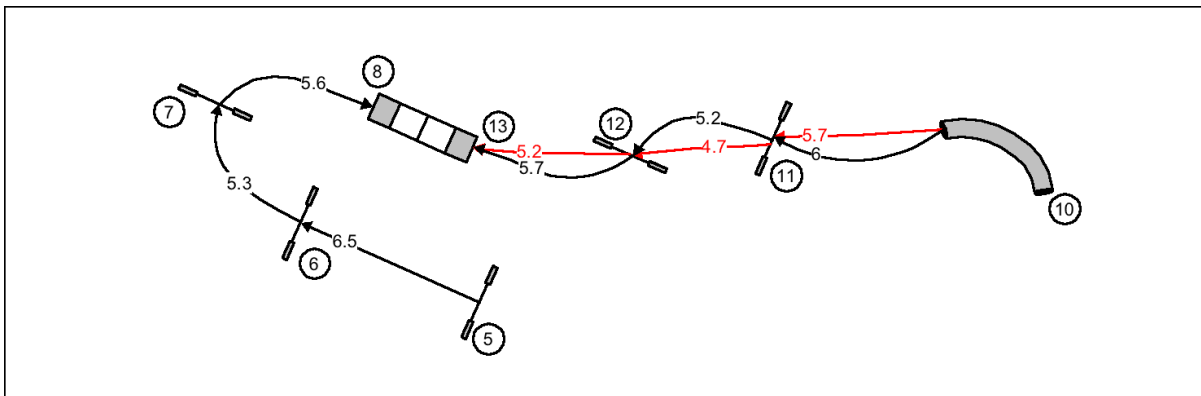

The sequence 7-8 from the left is exactly the same as the 12-13 from the right. The distance and angle 6-7 is the same as 11-12. Starting on the left, the distance between all obstacles is according to the rules.

Starting on the right, the judge could measure the distances - and stay within the rules - if he follows the same line he followed when starting on the left. Most dogs, however, will follow a line where the distances are shorter than stipulated in the rules. The situation is possibly dangerous because the dogs will attempt the A-frame at high speed and with only a short distance to prepare for it (the A-frame has an angled approach).

D) For safety, the rules specify that the dog should have a straight approach to the long jump, tyre, spread jump and flat tunnel (also straight exit). The approach and the speed of the dog should also be taken into consideration with the contact obstacles as is shown in the example above.

Examples on the right: all three are bad situations – the top two have two lines, one of which can be dangerous. The judge should not take the risk of a dog taking the wrong line. The bottom one speaks for itself.

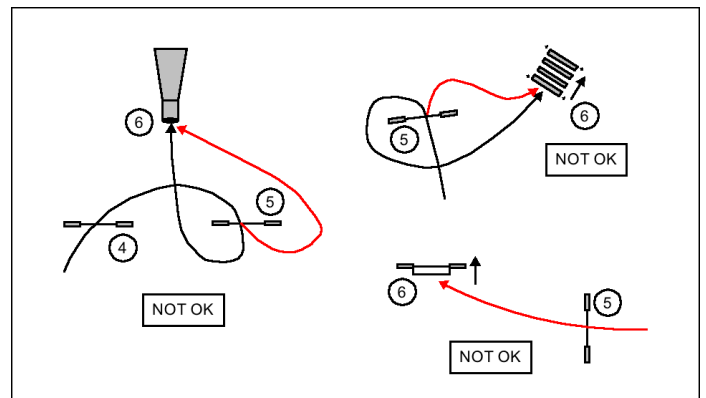

E) If there are two lines that the dog can take towards the next obstacle, the shortest line should respect the minimum distance defined in the rules.

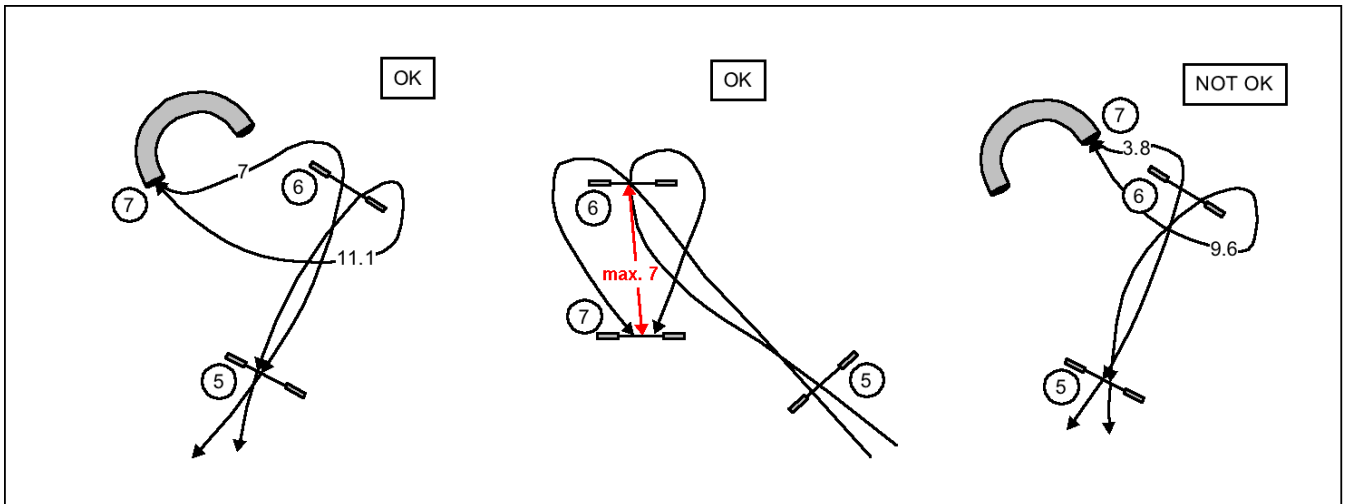

F) For safety, the wall/viaduct has to be placed in such a way that there is no risk of the dog hitting the tower while jumping. Tight turns or bad-angled approaches must be avoided.

Straight approaches on all obstacles that should have a straight approach:

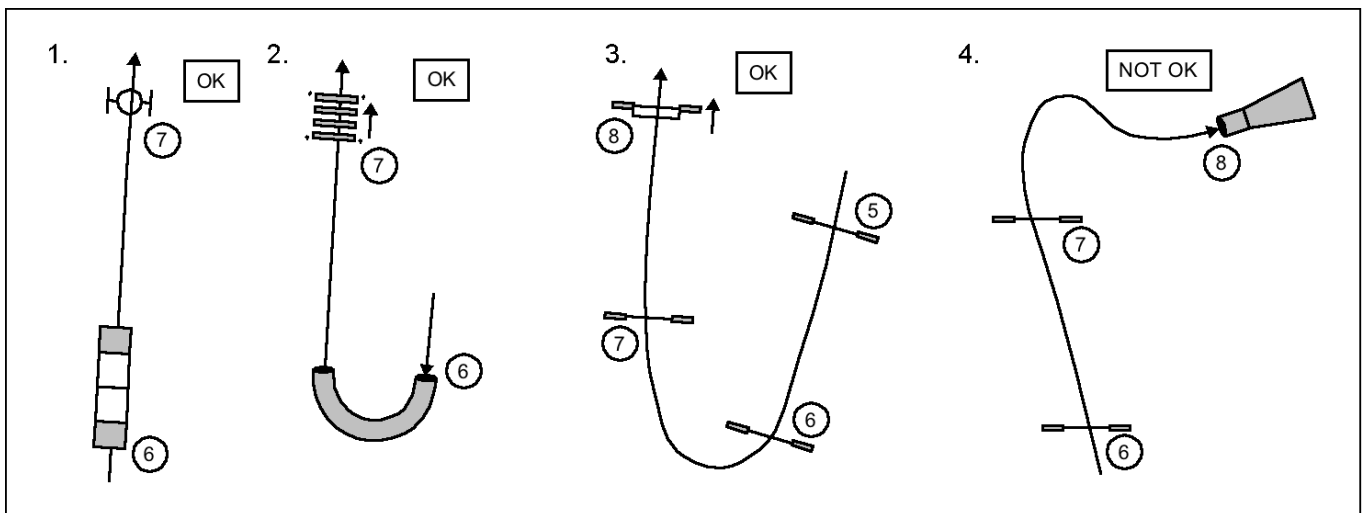

1. Straight approach to the tyre from a contact = OK, a very clear situation
2. Straight approach to the long jump from a tunnel = OK, another very clear situation
3. Straight approach from 7 to the spread, the dog already has a straight approach to the spread while it is jumping 7 (line from the landing point to 7 gives the dog the straight approach) = OK
4. Bad approach to the flat tunnel = NOT OK

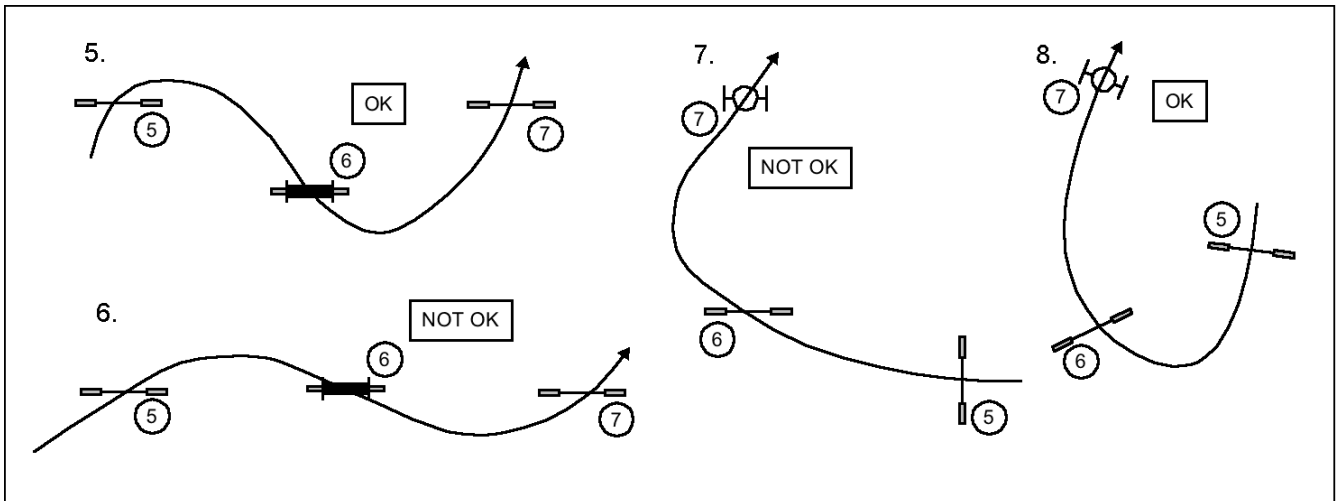

5. The line from the landing point to 6 results in a safe approach to the wall = OK.

6. In this situation (serpentine), the line from the landing point after 5 to 6 is too tight an approach to the wall = risk of the dog hitting the tower = NOT OK.

7. Although jump and tyre are placed one after another in the straight line, because of the line from 5, approach to the tyre is not straight = NOT OK

8. Straight approach from 6 to the tyre. After the landing, the dog already has a straight approach to the tyre (the line from the landing point to the tyre gives the dog the straight approach) = OK

When thinking about the approaches to the obstacles which should have a straight approach, you have to think about both the angle of approach AND the speed of the dog from the previous obstacle.

G) Tube Tunnel / Tyre

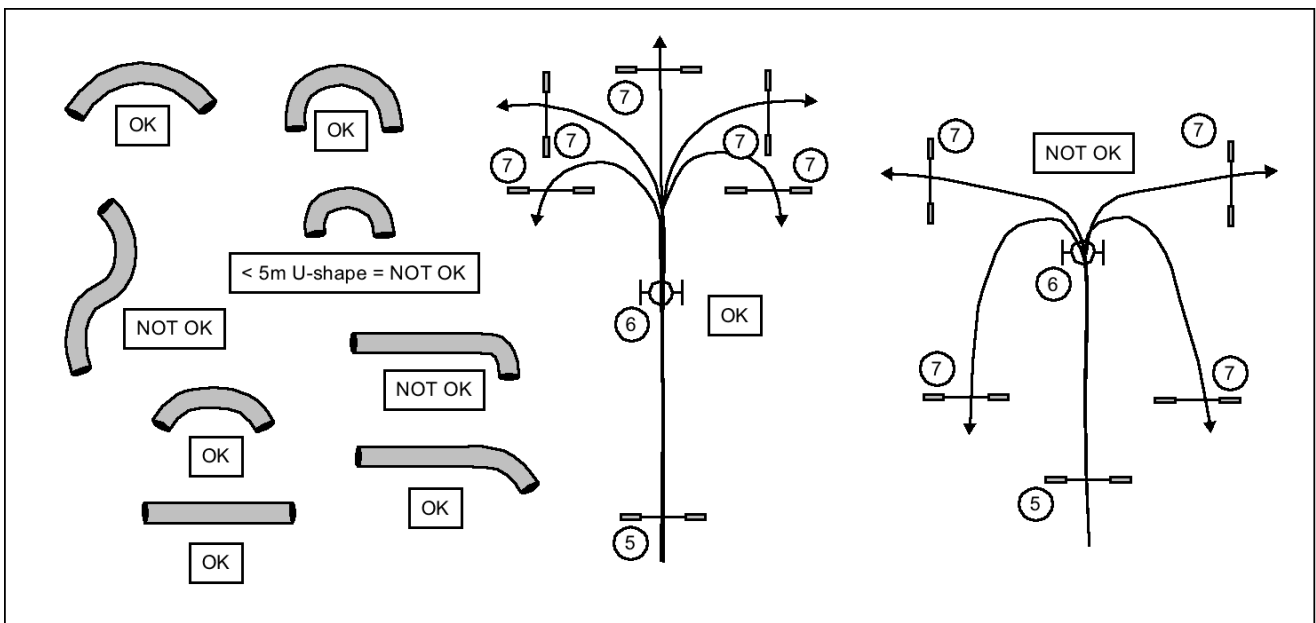

- Tube tunnels must always be pulled out to their full length.
- A tube tunnel can only be bent in one direction = NO S-shapes.
- Tunnels shorter than 5 m should not have a turn of more than 90° (examples on the left).
- Avoid tight turns after the tyre.

H) Handlers must have the possibility to pass each obstacle on both sides. The distance between two obstacles should be at least one meter (tunnel underneath the dog-walk or A-frame is the only exception). **Even the distance between two tunnel openings should be minimum 1 meter.**

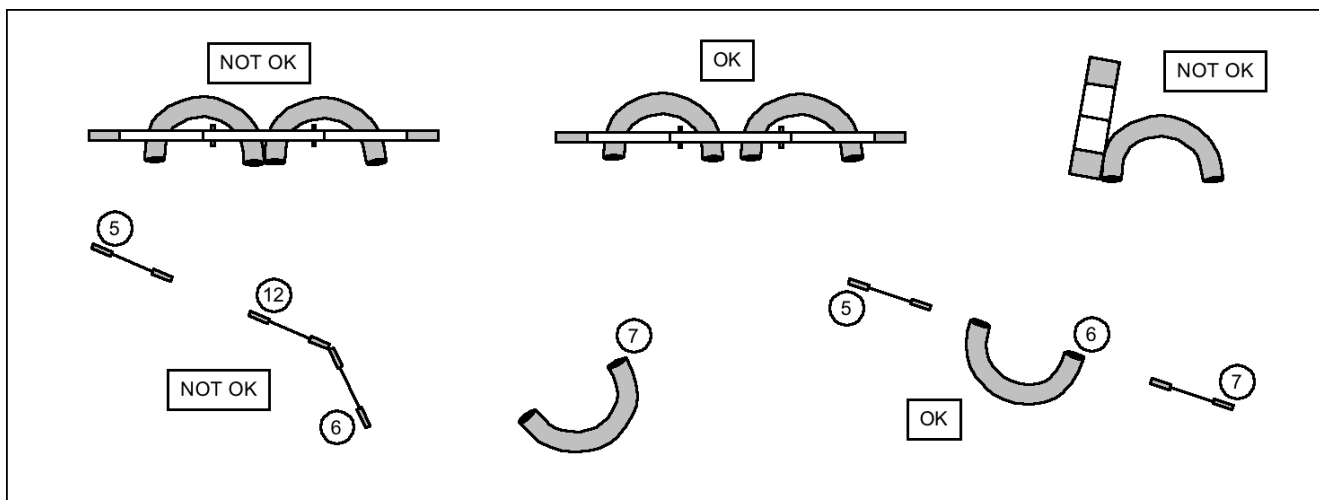

I) Obstacles other than hurdles and spread jumps can be classified as either primary or secondary obstacles:

Primary obstacles: A-ramp - dog-walk - see-saw – weave poles

The judge should always try to be at an appropriate distance and have a clear line of sight while the dog is negotiating these obstacles (without hindering and/or disturbing the handler or his dog; running next to these obstacles should be avoided). Judging primary obstacles from too far away is not recommended.

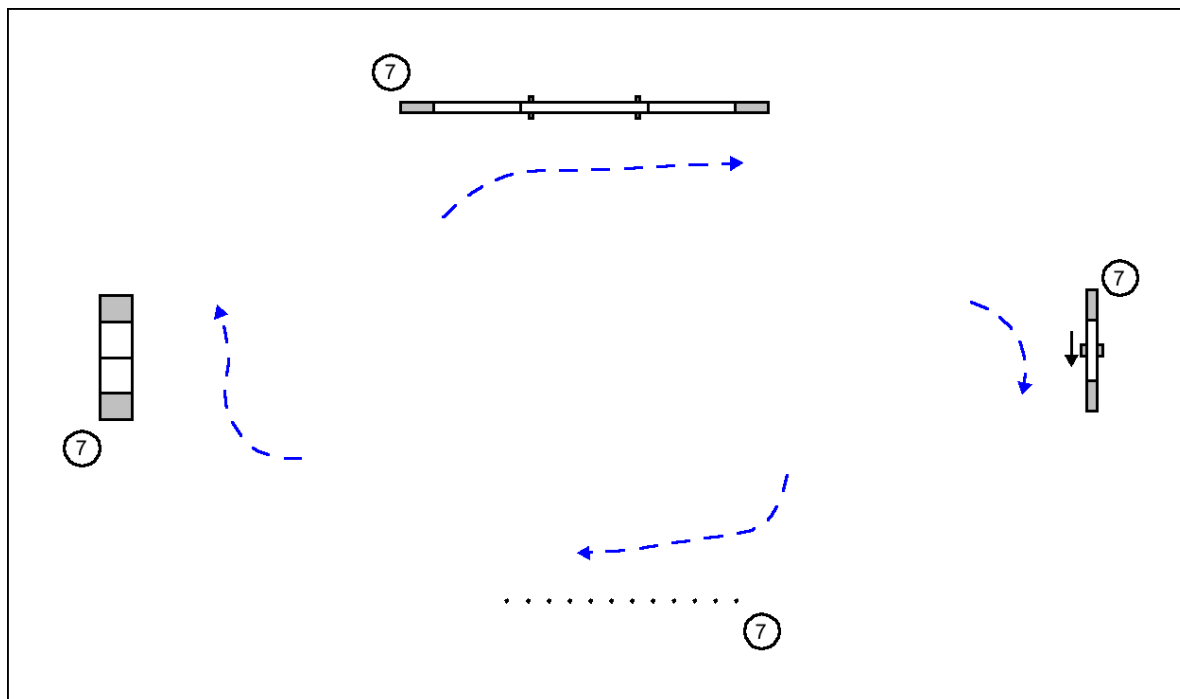

Secondary obstacles: Tube tunnel - Collapsible tunnel - Tyre - Long jump - Wall

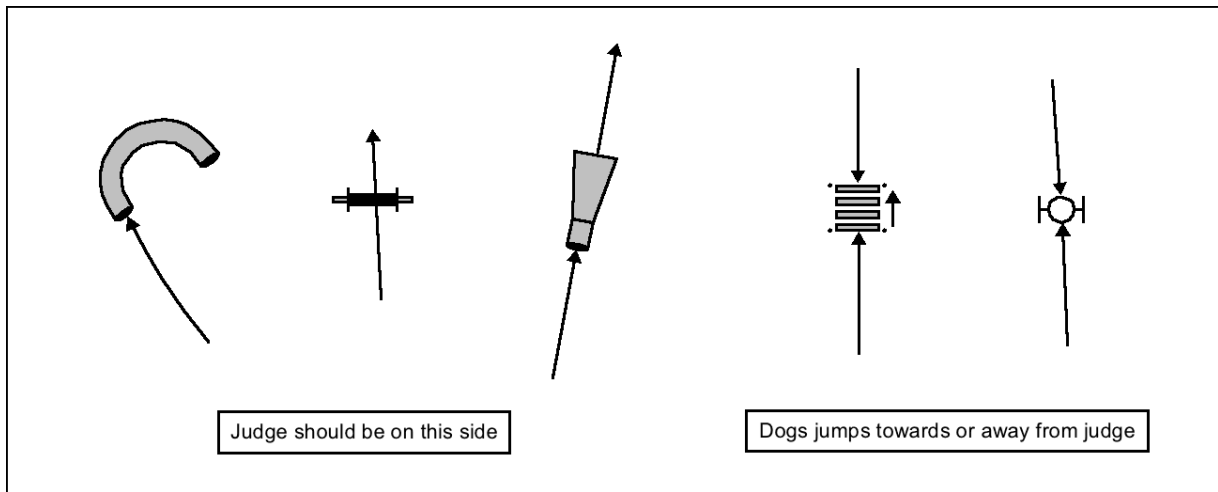

For tunnels and the wall, the judge should make sure that he is in the correct position to see any run by, turn-away or incorrect entry.

With the tyre and long jump, the judge should have the dog jumping towards him or away from him.

Difficulty with secondary obstacles in the course:

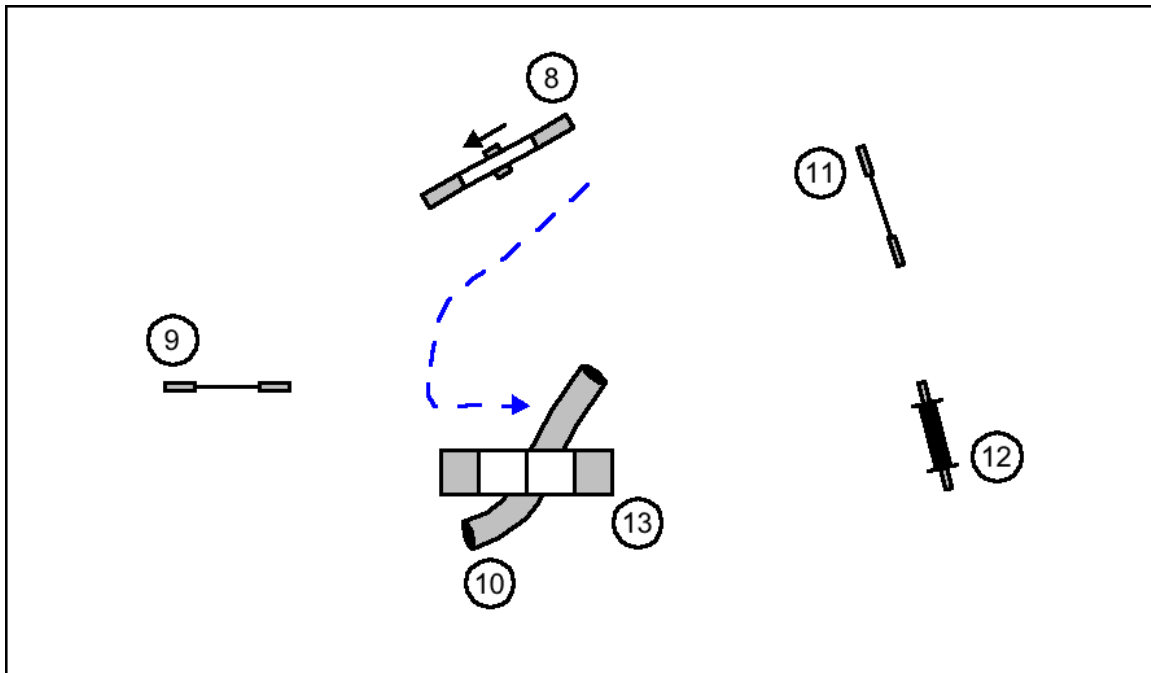

The judge cannot see the entrance to the tunnel (10) or possible refusals at the wall (12).

Other obstacles

Single hurdles or spread jumps do not pose particular problems for the judge. He should be at a slight angle to these obstacles so that he can see the poles knocked down or possible refusals.

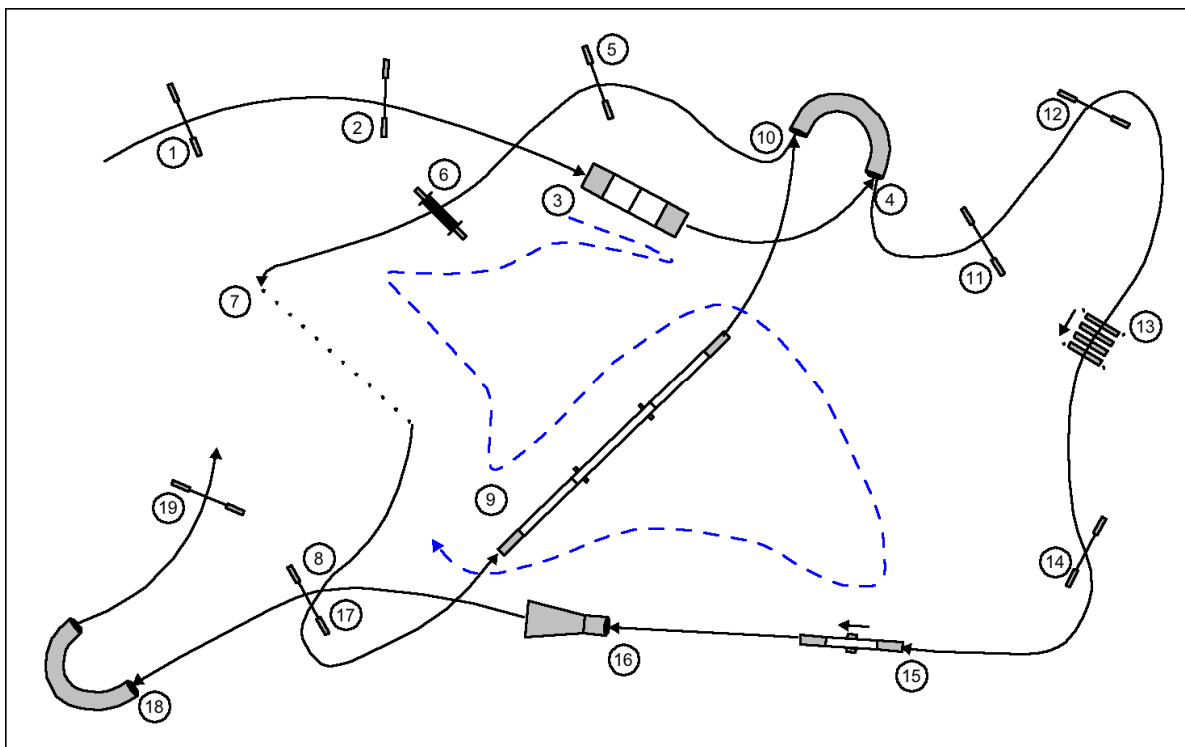

The judge waits alongside the primary obstacle 3, seeing the contacts, waits until the dog enters the tunnel, moves to the correct angle to see the weave entry, follows the dog to the dog-walk, waits at the up contact and moves with the dog to the down contact. He waits until the dog enters the tunnel and moves (while the dog is negotiating 11-12) to 15 (where he has a good view of the long jump) and after 15 – the last primary obstacle – he checks the entry to the flat tunnel. He then moves slowly to the triangle 7-9 and sees the dog entering the tunnel 18.

J) Course design guidelines

- While judging the dog, the course design should allow the judge to do this at a normal pace. For the dog-walk, it's much harder to focus on the contacts while running.
- It should never look like the judge cannot cope with the speed of the dog.
- The course should have the right degree of difficulty.
- A course should be fluent and safe. When thinking about safety, the judge should think about off-course obstacles.

K) The following should be avoided:

- Placing 2 **contact obstacles** one after the other.
- **Placing weaving poles before or after contact obstacle is allowed, but the judge should be aware of potential problems that judging such a combination could cause.**
- Sharp turns in the course that turns the handler into the judge's path – particularly after contact obstacles and weave poles.
- Using the spread jump more than once in a course.
- Less than 6 (with primary obstacles) or 8 (without primary obstacles) obstacles between the 1st and the 2nd time a hurdle is used.

L) A course should be designed so that:

- Off-course obstacles should not be a possible danger for the dog (**examples below**: a misunderstanding or not enough control over the dog, could lead to the dog crashing into off-course obstacle).
- It is fun to watch for the spectators.
- It can be judged without problems.
- The course flows fluently, even for the more advanced classes (the course time can also be a degree of difficulty).

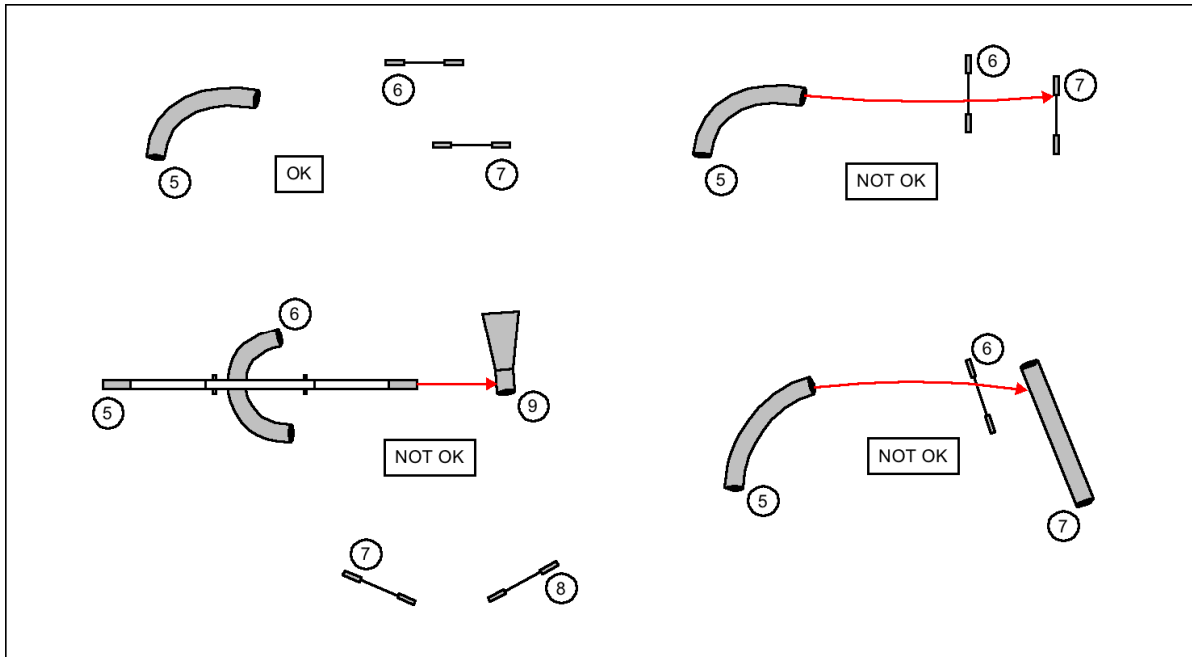

M) Time is saved when:

- The course is shortened.
- The exit is used optimally so the next dog can start sooner.
- There is a separate start and finish (have someone place the dog's lead near the finish).
- The scribe and time keeper are positioned near to each other.
- The start/finish hurdles are close to the entry/exit of the ring.
- The course design prevents the handler from going too far ahead before starting the dog.

10. Course building

The judge should use all FCI approved obstacles at least once during an FCI event.

The agility judge always supervises course building personally.

Weather conditions or ring-surface could require adjustments to the course design.

The judge should not use any obstacle that is not conformed to FCI-rules.

For the safety of the dog, the judge should inspect the obstacles to make sure they are not dangerous. Faulty obstacles must not be used.

If possible, the judge should see to it that the position of all obstacles that could be moved by dogs traversing them are marked.

After the briefing and after the course has been walked, no changes are allowed to the course or the Maximum Course Time (the Standard Course Time as well, if it is announced by the judge).

The poles marking the corners of the long jump are placed in such a way that they can be put back in exactly the same position if they are knocked down.

The numbers should be placed in such a way that they do not hinder the dog or the handler during their run.

A U-shaped tunnel is the only obstacle where the number can be placed in the middle to indicate that either side can be taken – in this case the refusal line must be the same for both entries.

Tunnels must always be used completely extended (full length).

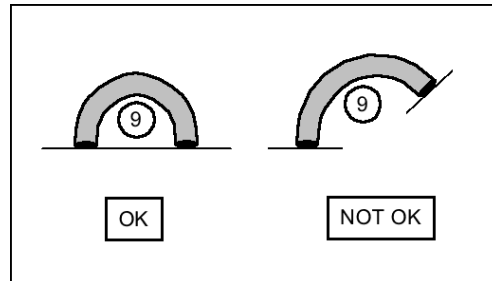

Before the course-walk, the judge makes sure that:

- The course is what he expected.
- It resembles the design.
- All the obstacles are firmly placed and, when necessary, pegged down.

Before the first dog starts, the judge makes sure that:

- All the helpers are correctly briefed and that they are where they are supposed to be.
- All the obstacles are put up correctly.

11. Standard Course Time and Maximum Course Time

In trials at international agility competitions (including FCI-AWC, EO, JOAWC, FCI-CACIAg), the SCT is determined by time of the fastest dog with the fewest faults + 15% and rounded up to the nearest second, and the MCT is determined by dividing the length of the course by 2.0 m/s in agility, 2.5 m/s in jumping.

But if the Standard Course Time is set by the judge, he must first know the exact length of the course.

A measuring wheel is recommended to determine the length of the course (the most precise method).

The judge should measure the ideal line the dog will use when it negotiates the course. Ideally, measurement should be from the centre of each obstacle. The judge does not need to measure the length of the tunnel, which can just be added on to the measured length.

When assessing the Standard Course Time, the following should be taken into consideration:

- The nature of the competition.
- The degree of difficulty.
- The weather conditions.
- The condition of the ring-surface.

12. Judging

The judge is responsible for what happens in his ring and he should make sure that everything goes as smoothly as possible.

A handler can bring his dog into the ring without lead and collar if the handler is in control of the dog.

The performance of each dog should be judged correctly and consistently. In order to do so, the judge must always move to the right position on the course. It is always a good idea for the judge to go over his judging path a few times before the start of the trial.

The judge's position should not interfere with the dog or the handler and he should make sure not to cross in front of the dog or the handler as they are coming toward him.

The position of the scribe should allow him to see the judge at all times. However, the scribe can be told to move if necessary. If the judge is temporarily out of sight of the scribe because of an obstacle such as the A-frame, then the judge should hold up his arm up long enough to make sure that the scribe has seen the signal.

The judge should never take his eyes off the dog as long as it's in the ring, even after it's been eliminated.

Each attempt to negotiate an obstacle must be judged. **An attempt is defined as the dog being within a distance from the obstacle where it should be capable of negotiating it from the correct side; however, it is also judged to be an attempt if there is any physical interaction with the obstacle – even when the dog is behind the refusal line.**

Considered to be exceptions: the dog going over tunnel, through the weaving poles or under the dog walk/A-frame when he is, after refusal, coming back to the handler.

13. Judging specific obstacles

13.1 Hurdle

It is a fault when the dog displaces a pole so that it is no longer at the original height (a pole does not have to fall to the ground to be faulted).

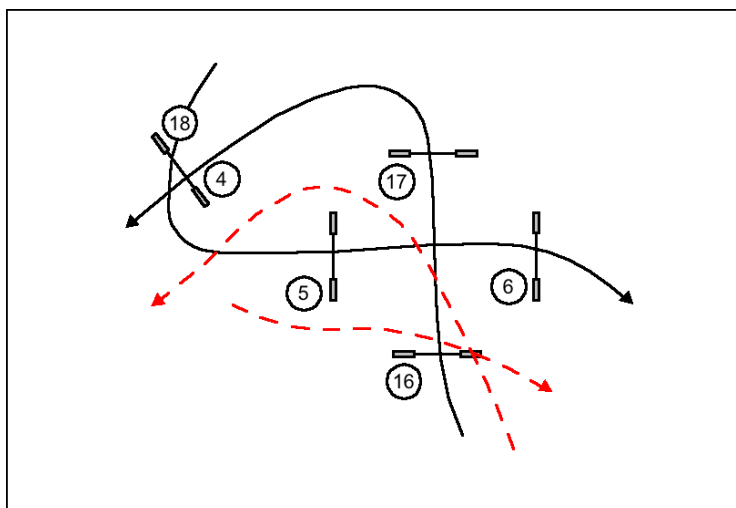

Examples:

- Dog knocks down 4 = fault. Not elimination, even if the wing falls down, whether there is enough time to rebuild it or not.
- Handler knocks down 16, while dog is jumping 6 = Elimination
- Handler knocks down 16, while dog is jumping 16 = Fault if it is not 100% sure if it was the handler.
- Handler knocks down 16, while dog is jumping 17= Elimination
- **Handler touches a hurdle, but no advantage is gained = No fault.**

13.2 Contact obstacles

- The judge should concentrate on the contact zone to assess whether the dog puts any part of a paw on it. This method is better than concentrating on the dog, where a back paw in the contact zone could be missed as the dog leaves the obstacle.
- A dog cannot be faulted for stopping, backing up, turning or going in the wrong direction as long as it is on the obstacle. The dog must, of course, complete the obstacle correctly and in the right direction. The down contact is judged when the dog leaves the obstacle, even if the dog touched that contact before backing up.
- A dog can stop in the contact zone, even if it is partially on the ground and partially on the obstacle.
- Once the dog has left the obstacle, i.e., by touching the ground with all four paws, it is eliminated if it puts a paw back on the obstacle.

13.3 Long jump

The marker poles at the four corners of the long jump are only a judging aid. They help determine whether the dog has negotiated the obstacle correctly. Therefore, no faults are incurred when a dog or handler touches or knocks down one of these poles, even when this causes one of the units to fall down.

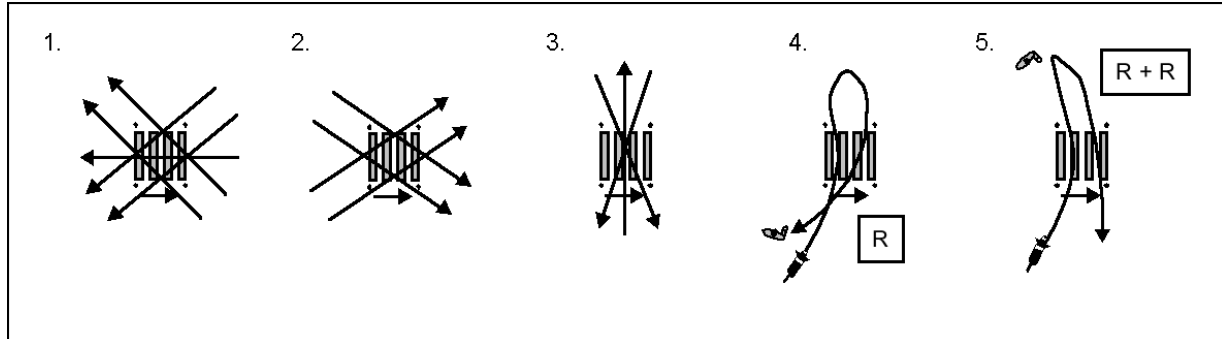

Examples:

1. The dog jumps in and out of the long jump in the wrong direction = E
2. The dog jumps in and out of the long jump in the right direction = R
3. The dog jumps in and out of the long jump from side to side = R
4. The dog jumps in and out of the long jump from the side and jumps back towards the handler = R (not R+R)
5. **The dog jumps in and out of the long jump from the side towards the handler; handler then sends him back for a second attempt and dog jumps in and out of the long jump from the side again = R+R**

13.4 Weave poles

It is a fault if the dog leaves the line that allows continuous forward movement for more than the dog's own length. Regarding the entrance to the weaves, allowance should be taken into consideration for speedy dogs and acute angles of entry.

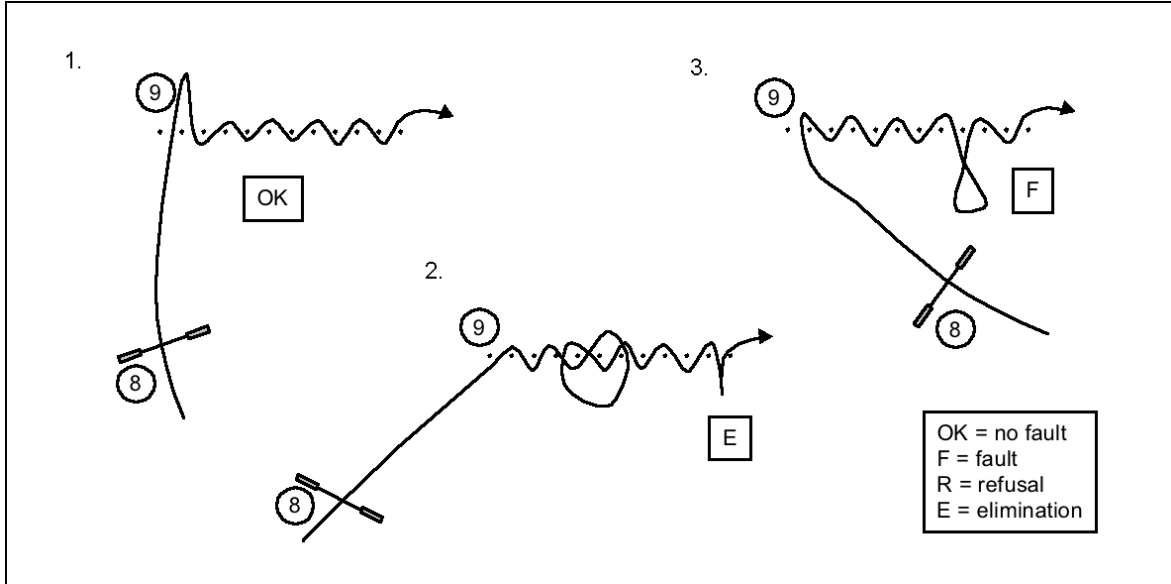

Examples:

1. Allowance is made because of the acute entrance to the weave poles = OK
2. Correct entry, mistake in the middle of the weave that is not corrected properly and subsequently the dog continues through the wrong gates coming out the weave the wrong way: the handler then only corrects the wrong exit = E
3. The dog moves away from the weave poles more than his own length = F

14. Judging situations

14.1 Refusals and subsequent marking

Definitions

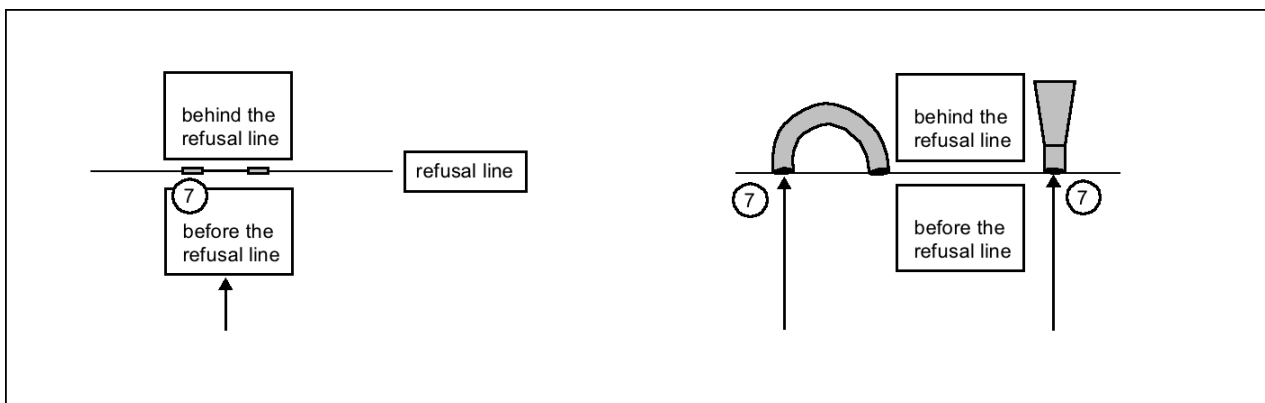

The area around an obstacle can be separated into two areas by a line, called the refusal line (RL), perpendicular to a straight-line approach to the obstacle. The side from where the dog should approach the obstacle is called 'before the refusal line'. The other side is called 'behind the refusal line'.

If the dog starts before the RL, it is not allowed to cross the RL or it will be faulted with a refusal.

If the dog starts behind the RL, it has to cross the RL once to negotiate the obstacle from the right side. The dog will be faulted with a refusal if it crosses the RL more than once without negotiating the obstacle.

A dog can only be faulted with a refusal when it is on the side of the obstacle from which it should be negotiated.

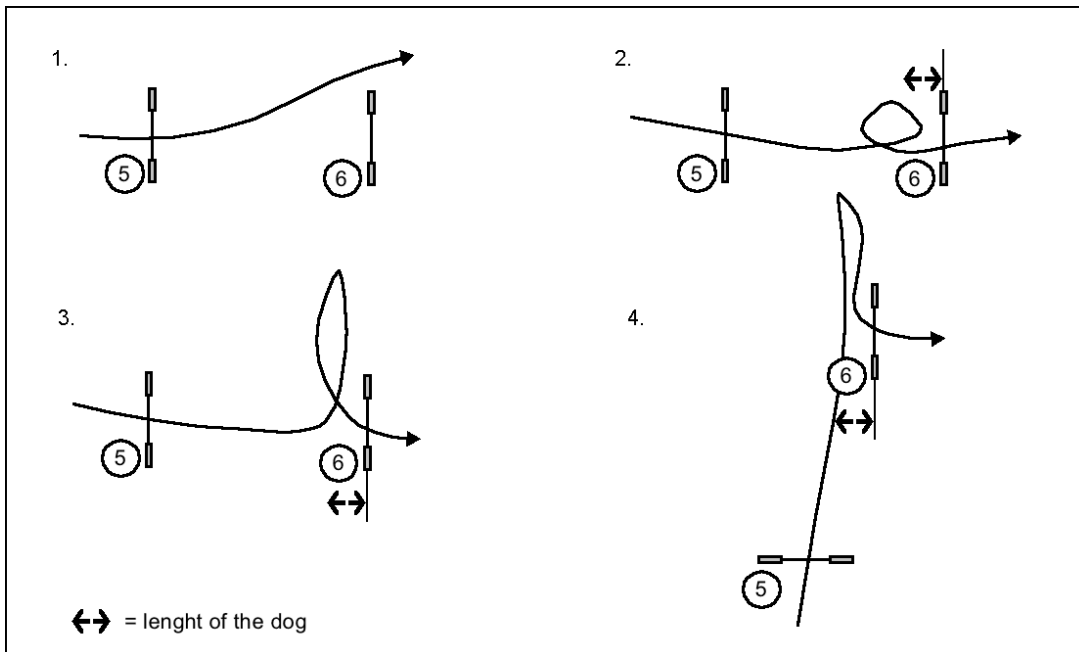

Examples:

1. The dog runs by the obstacle.
2. and 3. The dog turns away from the obstacle.
4. The dog passes in front of the obstacle.

A judge has to be careful when designing his course not to take the dog too close to the RL while it is negotiating the course. It just makes it more difficult to decide whether or not there is a refusal.

Note that whenever a dog makes an attempt to negotiate an obstacle, it can still be faulted with a refusal even if it does not cross the RL (e.g., by turning away from an obstacle or by running in front of it without taking it, see previous picture).

Example:

In the example on the right, the handler hangs back and sends his dog to negotiate the tunnel (obstacle 13). The dog jumps over the tunnel (R) and runs back to the handler. The handler sends his dog again – with the same result. Since this is another attempt to negotiate the obstacle: 2nd R. The dog is sent a third time and finally enters the tunnel.

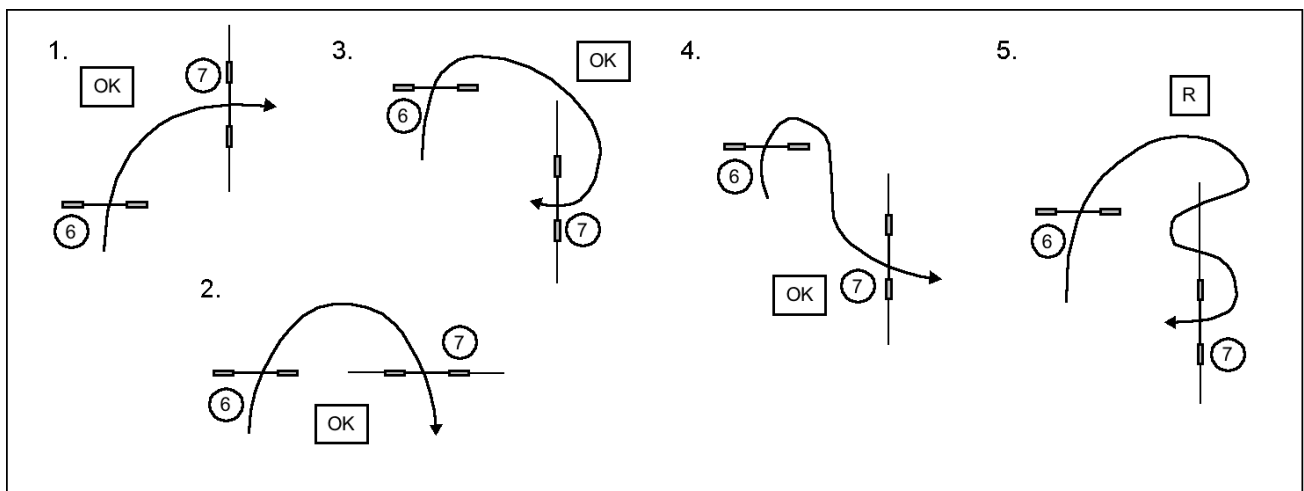
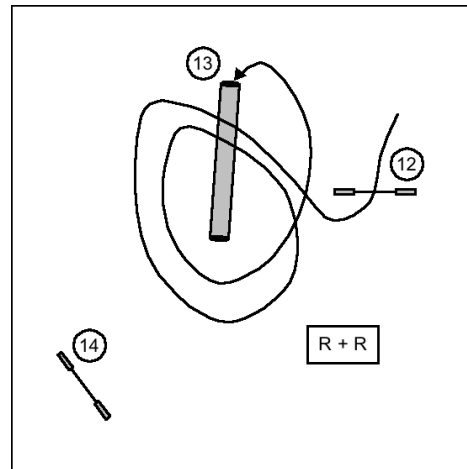

Examples:

- 1 and 2. Dog lands before the RL of the next obstacle and does not cross this line = OK
3. Dog lands behind the RL of the next obstacle (7) and crosses this line just once.
4. Dog lands before the RL of the next obstacle and does not cross this line = OK
5. Dog lands behind the RL of the next obstacle and crosses this line more than once = R

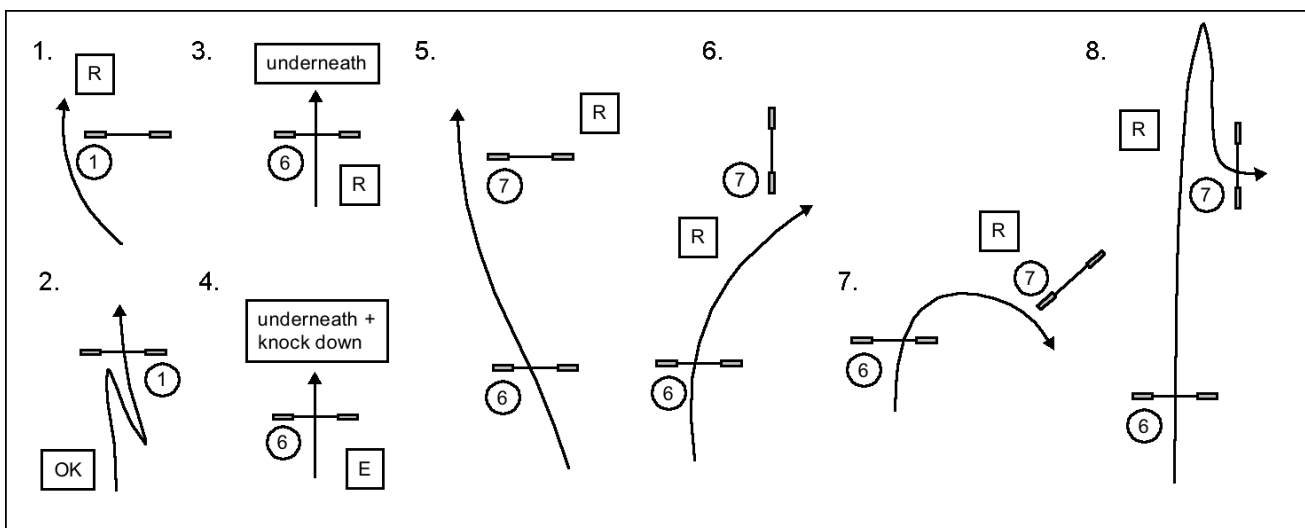

Examples:

1. Dog runs past 1st hurdle = R
2. Dog runs to and back from 1st hurdle before starting = OK
3. Dog runs underneath hurdle = R
4. Dog runs underneath, knocking down the bar: destroying the obstacle while negotiating it = E
- 5, 6 and 7. Dog lands before the RL of the next obstacle and crosses this line = R
8. Dog lands before the RL of the next obstacle and runs in front of it without negotiating it = R

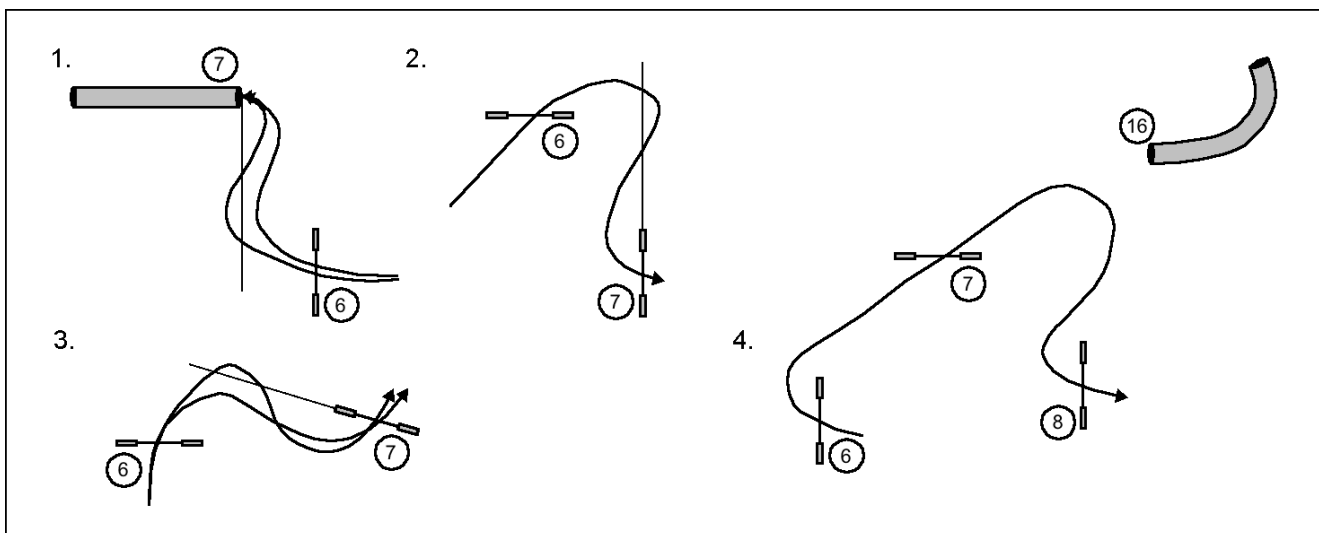

Examples:

- 1, 2 and 3. Short-striding dogs and slow dogs will land before the RL of the next obstacle and can turn towards it. Long-striding dogs and very fast dogs can land before the RL of the next obstacle but because of their body shape or speed they cannot turn without crossing the RL = OK
4. More extreme, but the dog ends up in area where he cannot go for the correct obstacle = OK

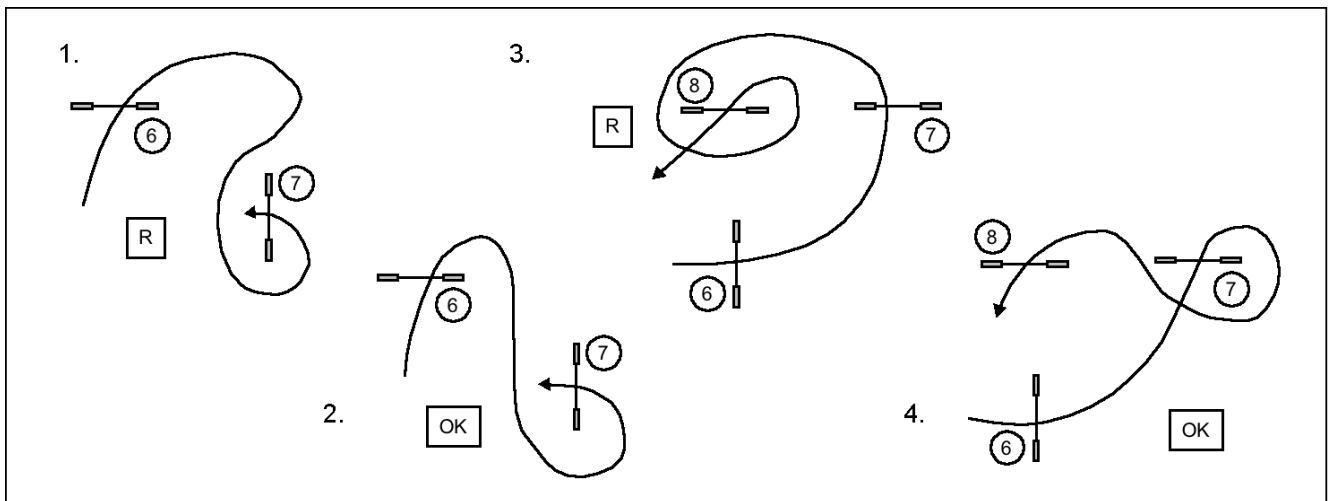

Examples:

1. Dog lands behind the RL of the next obstacle and crosses this line more than once = R
2. Dog lands behind the RL of the next obstacle and crosses this line just once = OK
3. Dog lands before the RL of the next obstacle (8) and crosses this line = R
- 4. Dog lands before the RL of the next obstacle (8), but turns in wrong direction and ends up in area where he cannot go for the correct obstacle, unless he crosses the RL again = OK**

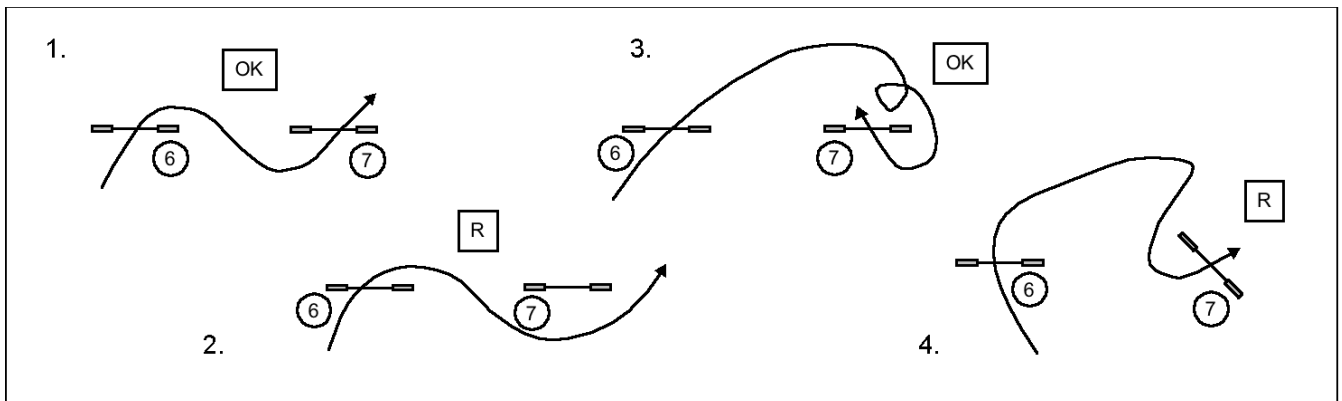

Examples:

1. Dog lands behind the RL of the next obstacle and crosses this line just once = OK
2. Dog lands behind the RL of the next obstacle and crosses this line more than once = R
3. Dog lands behind the RL of the next obstacle and crosses this line just once = OK, even if the dog turns round on itself behind the RL.
4. Dog lands before the RL of the next obstacle and crosses this line = R

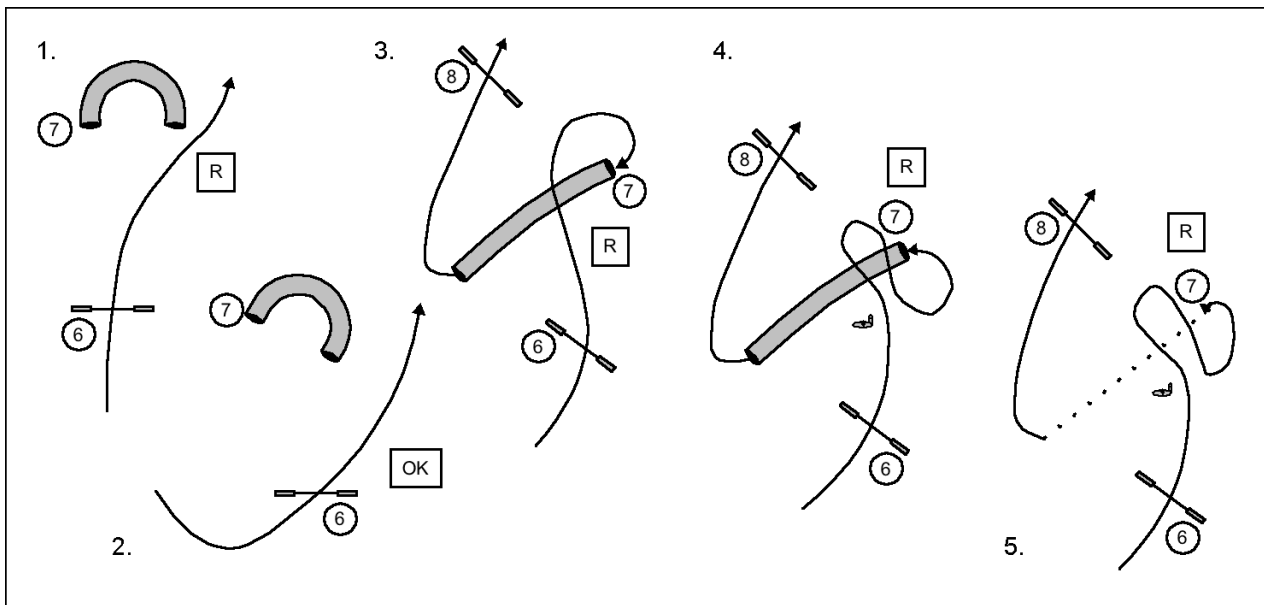

Examples:

1. Dog lands before the RL of the next obstacle (tunnel) and crosses this line = R

2. Dog lands before the RL of the next obstacle (tunnel) and crosses this line, but he ends up in area where he cannot go for the correct obstacle, unless he crosses the RL again = OK

3. Dog lands behind the RL of the next obstacle (tunnel), jumps over it and then enters it = R
(not E for a wrong course).

4. Dog lands behind the RL of the next obstacle (tunnel), jumps over it twice and then enters it = R (not R+R, since the dog makes only a single attempt at the obstacle, and not E for a wrong course).

5. Dog lands behind the RL of the next obstacle (weave poles), goes through it twice (**2nd time when going back to the handler**) and then enters it = R (not R+R, since the dog makes only a single attempt at the obstacle, and not E for a wrong course).

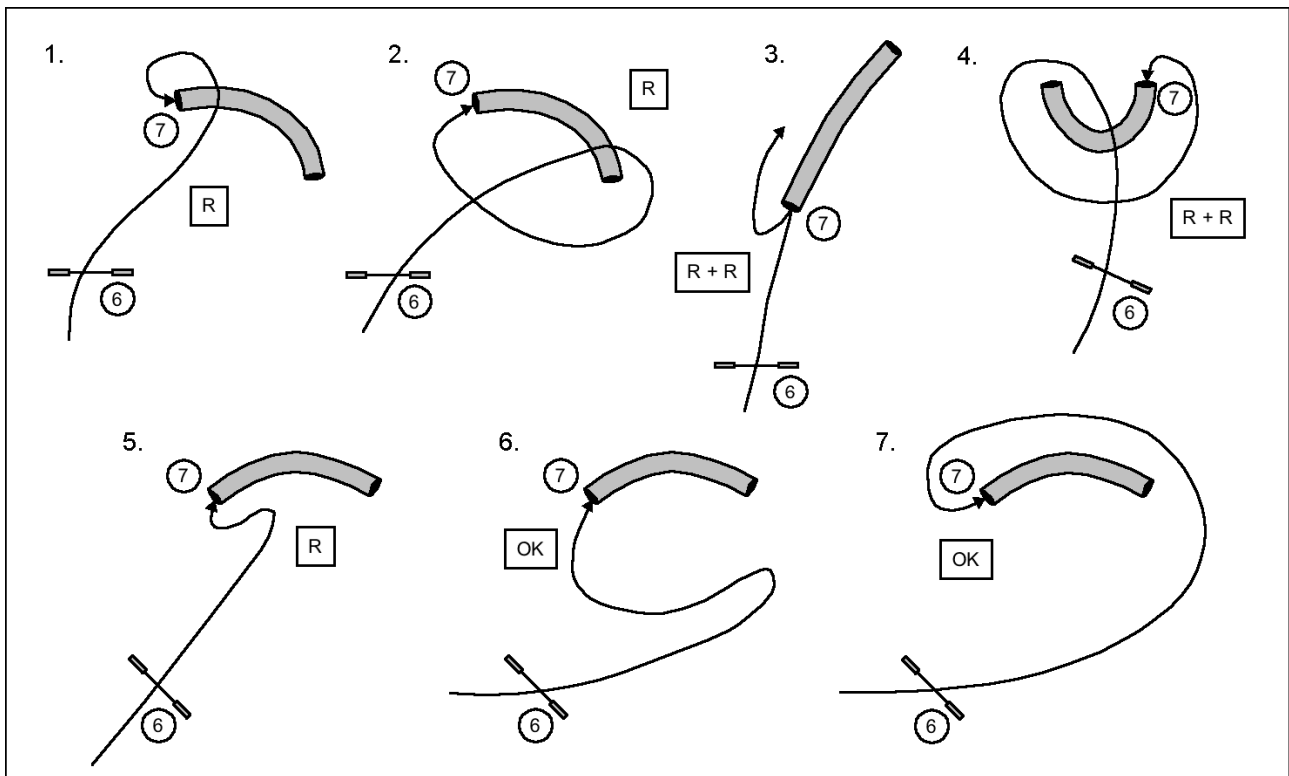

Examples:

1 and 2. Dog lands before the RL of the next obstacle (tunnel), crosses this line once and jumps over the obstacle it should take = R (not E)

3. Dog goes correctly in the tunnel, comes back out (refusal), and then runs by the tunnel, crossing the RL (2nd refusal) = R + R

4. Dog jumps over tunnel (refusal), turns back and crosses the RL of the tunnel (2nd refusal) = R + R

5. Dog lands before the RL of the next obstacle (tunnel), crosses this line more than once = R

6. and 7. Dog lands before the RL of the next obstacle (tunnel), crosses this line once, but he ends up in area where he cannot go for the correct obstacle, unless he crosses the RL again = OK

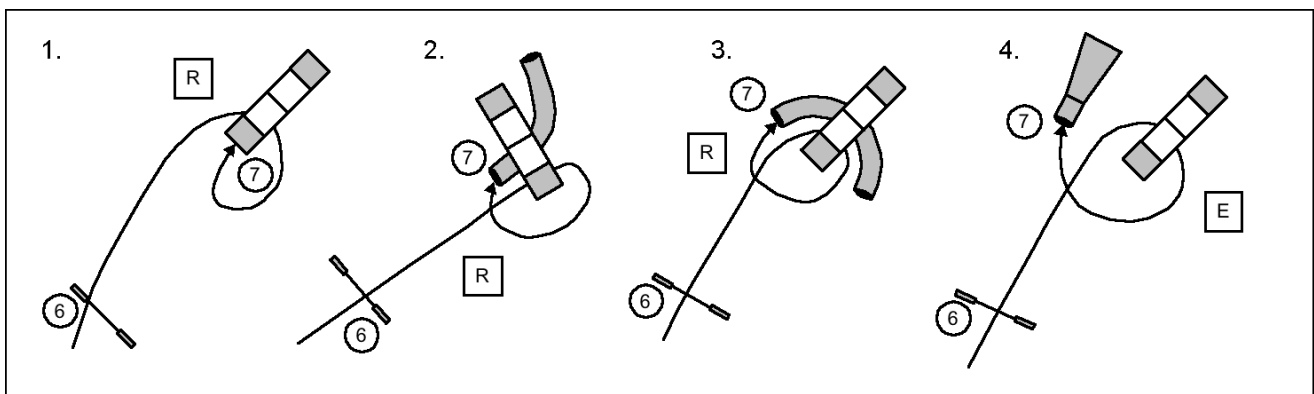

Examples:

1. Dog lands before the RL of the next obstacle (A-frame), crosses this line once and goes under the obstacle it should take = R (not E).
2. and 3. Dog lands before the RL of the next obstacle (tunnel), crosses this line once and goes under an obstacle it is not allowed to take (A-frame). However, in this situation, created by the judge, the dog cannot avoid it = R (not E).
4. Dog lands before the RL of the next obstacle (flat tunnel) and goes under an obstacle it is not allowed to take (A-frame) = E

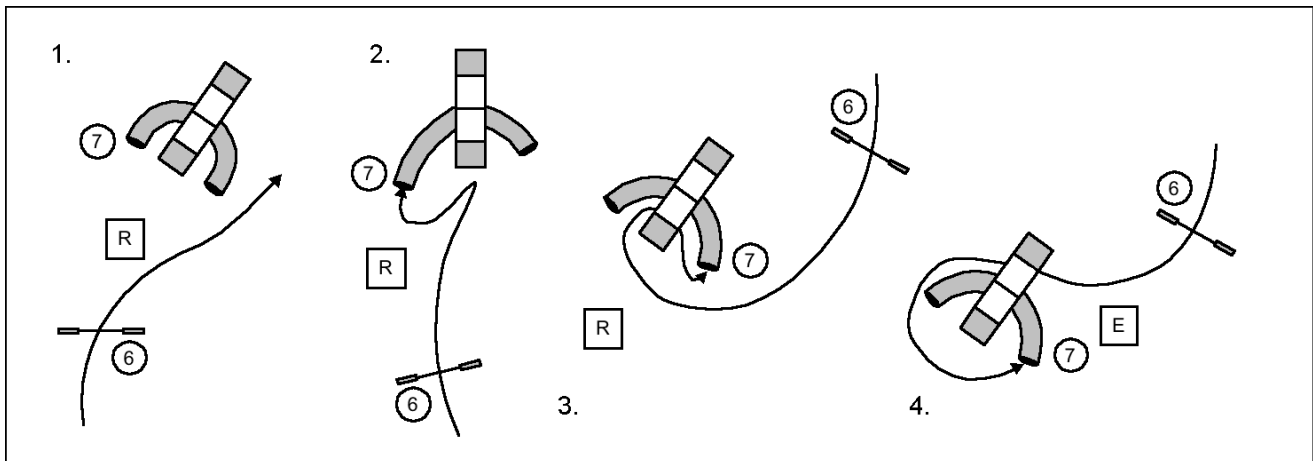

Examples:

1. Dog lands before the RL of the next obstacle (tunnel) and crosses this line = R
2. Dog lands before the RL of the next obstacle (tunnel) and crosses this line by going towards the A-frame = R (the dog sees the tunnel during his approach to the A-frame)
3. Dog lands behind the RL of the next obstacle (tunnel), crosses this line once and goes under an obstacle it is not allowed to take (A-frame). However, in this situation, created by the judge, the dog cannot avoid it = R (not E).
4. Dog lands behind the RL of the next obstacle (tunnel), not crossing this line and goes under an obstacle it is not allowed to take (A-frame) = E

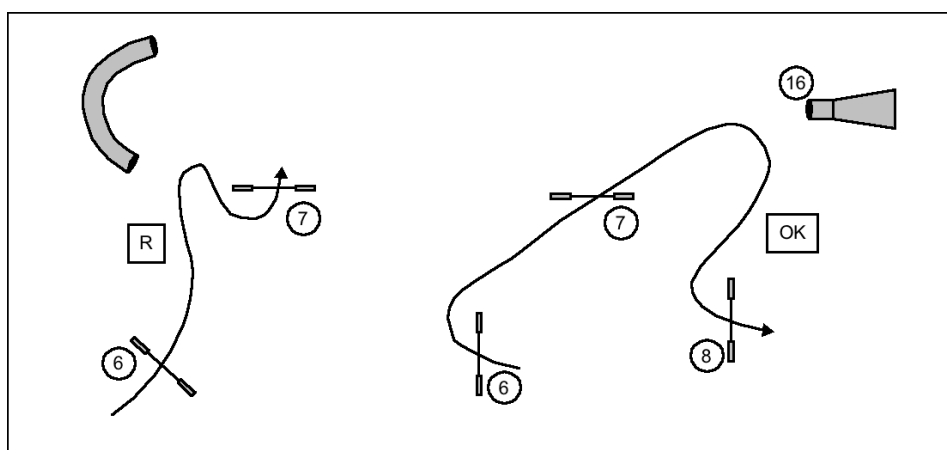

Examples:

Refusal with/without going for the wrong obstacle.

Left: Dog lands before the RL of the next obstacle (7) and crosses this line = R

Right: Dog lands before the RL of the next obstacle (8) and crosses this line while it is not in an area where it can go for the correct obstacle = OK

These 2 situations are clear, all situations in between have to be decided by the judge at that moment.

If a dog stands still or turns around in the take-off area, the dog will be faulted with a refusal.

The 'take-off' area depends on the size of the dog. Short striding dogs automatically have smaller areas 'to take off in' than long striding dogs. It is up to the judge to decide there and then. Two guidelines can be used to help make the decision:

1. If the dog goes within one dog-length of the obstacle and does not take it, then it is a refusal.
2. When the dog turns and the judge thinks "why didn't the dog take off", then it is a refusal.

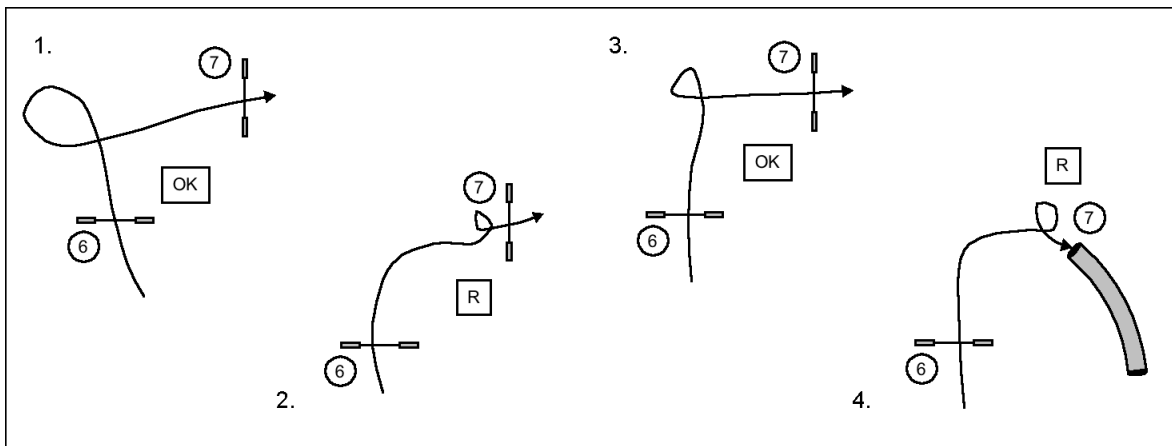

Examples:

1. Dog turns in an area where it cannot take off for hurdle 2 = OK

2. Dog turns in the area where it should take off = R

3. Dog turns in an area where it cannot take off for hurdle 2 = OK

4. Dog turns in the area where it should go into the tunnel (take-off) = R

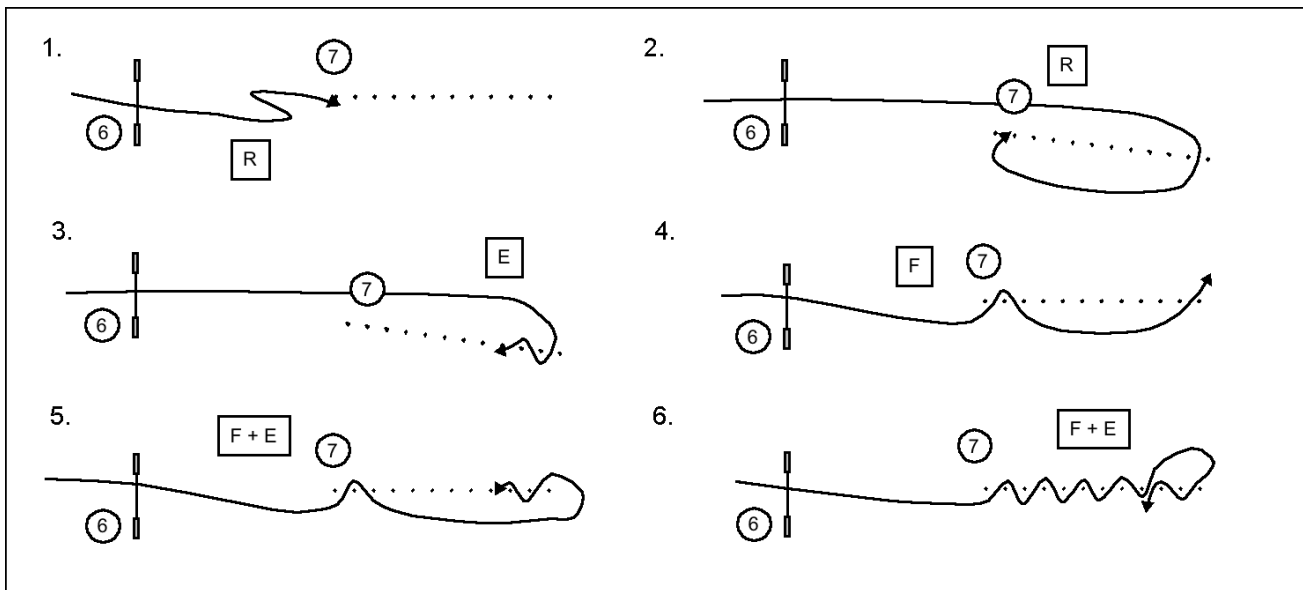

Examples:

1. Dog turns back in the area where it should enter the weave poles (take off) = R
2. Wrong entry, **no back-weaving** = R (the dog then goes for the correct entry)
3. **Back-weaving**: dog negotiates the obstacle (more than two gates) in the wrong direction = E
4. **Dog misses the gate = F**
5. and 6. **Dog misses the gate, then negotiates the obstacle in wrong direction = F + E**

14.2 Contacts, refusals and faults

Dividing into areas before and behind the RL does not really work for contact obstacles because the situation is somewhat different. Even when the dog is behind the RL it is still able to get on the obstacle – in which case, if the dog touches the up contact, it should not be faulted.

Here are some examples:

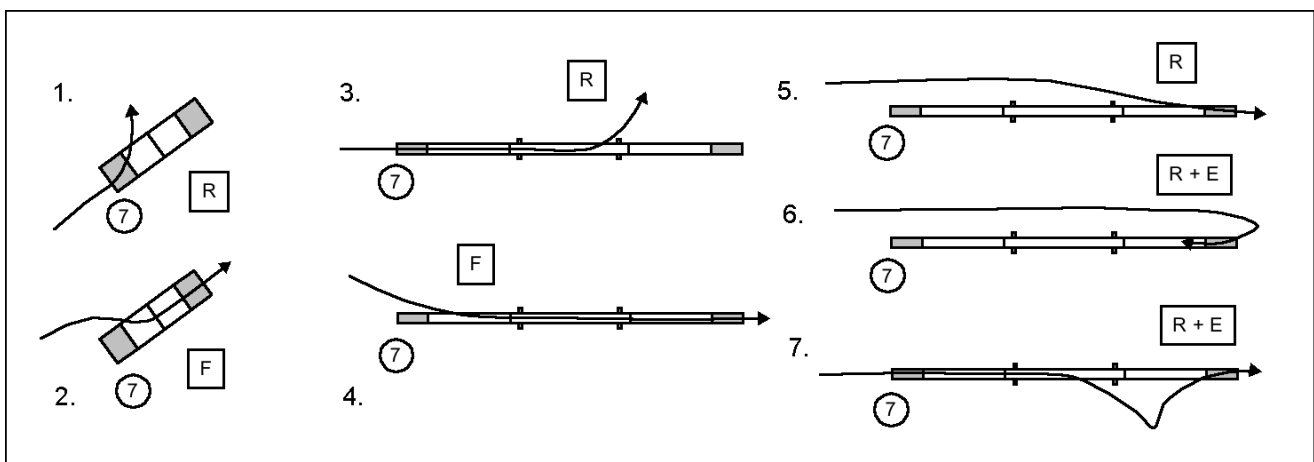

1. Dog touches the up contact, leaves the A-frame before touching the descending ramp = R
2. Dog gets onto the A-frame but missing the up contact = F
3. Dog touches the up contact, but leaves the dog-walk on the ascending or horizontal plank = R
4. Dog gets onto the dog-walk but missing the up contact = F
5. **Dog passes the dog-walk and touches the descending ramp in the same direction of his movements = R**
6. **Dog passes the dog-walk and then start to negotiate the obstacle in the wrong direction = E**
7. **Dog touches the up contact, leaves the dog-walk on the ascending or horizontal plank, then touches the descending ramp in the same direction of his movements = R, and if he continues to the next obstacle = E**

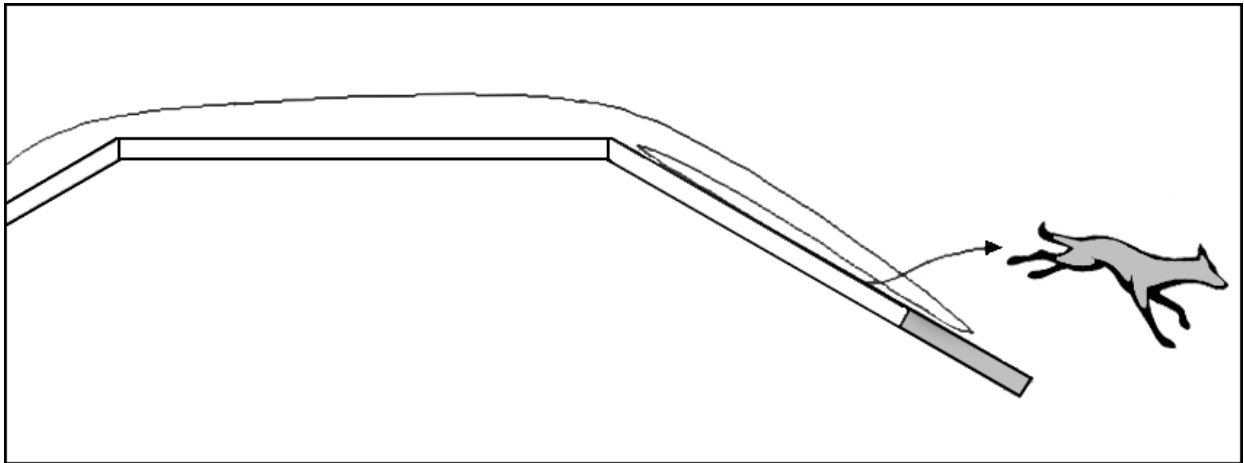

The dog misses the contact as he jumps off the obstacle = F, even though he touched the contact before backing-up.

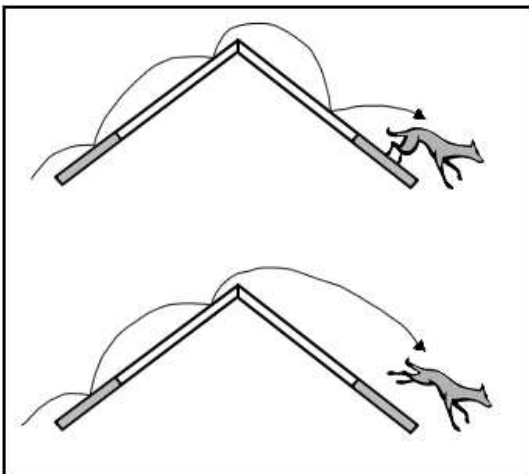

Examples:

Top: Dog comes down the A-frame, touching the down ramp with four paws. It then jumps off before touching the contact area, lands with two paws on the ground and falls back on the contact with the back paws = OK

Bottom: Dog jumps over the top of the A-frame and lands, without touching the down ramp with any paw, straight onto the ground with its two front paws (even if it falls back onto the contact with its two back paws) = E

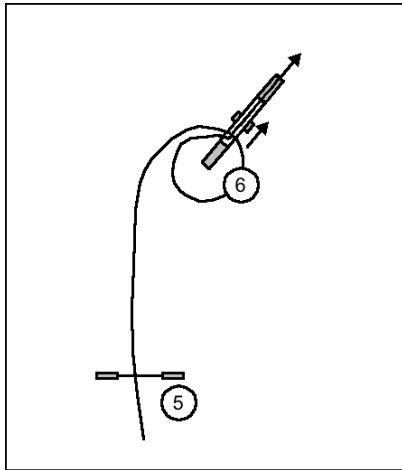

Examples:

1. Dog passes the upside of the see-saw, jumps on the upper side plank of the see-saw (F), jumps off on the other side of the plank (R), runs around the upper side, misses the up contact (F) and negotiates the rest of the see-saw = F+R+F

2. Dog passes the upside of the see-saw, jumps over the plank of the see-saw (R), runs around the upper side, misses the up contact (F) and negotiates the rest of the see-saw = R+F

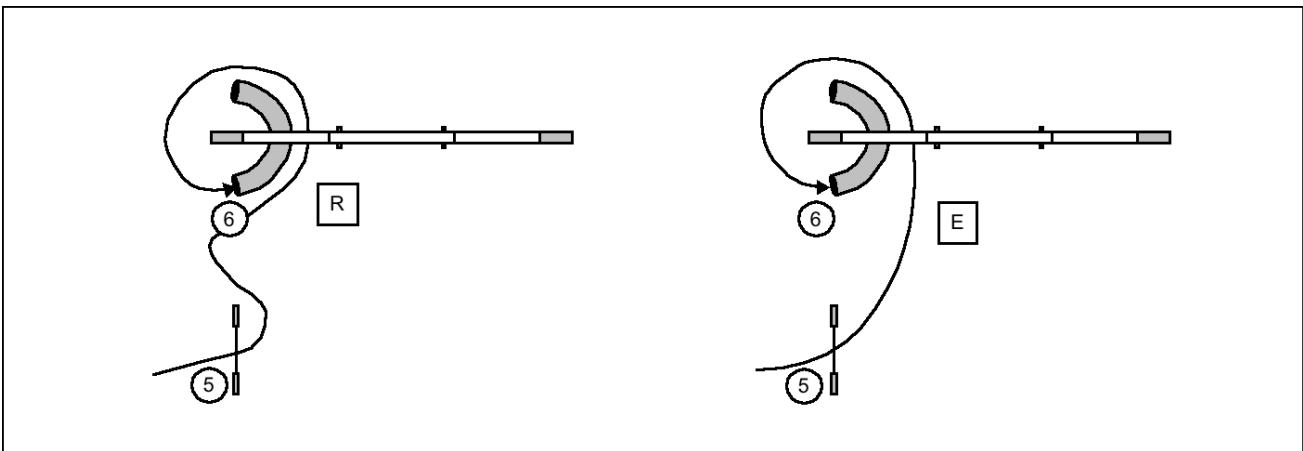

Examples:

Left: Dog lands behind the RL of the next obstacle (tunnel) and crosses this line twice = R (refusal of the tunnel, not wrong course for going under dog-walk)

Right: Dog lands behind the RL of the next obstacle (tunnel) and goes under wrong obstacle = E (no refusal of the tunnel)

14.3 Judging a flyer on the see-saw

Judging flyers is not always easy.

Definition of leaving the sea-saw = paws in the air, there is no paw contact whatsoever.

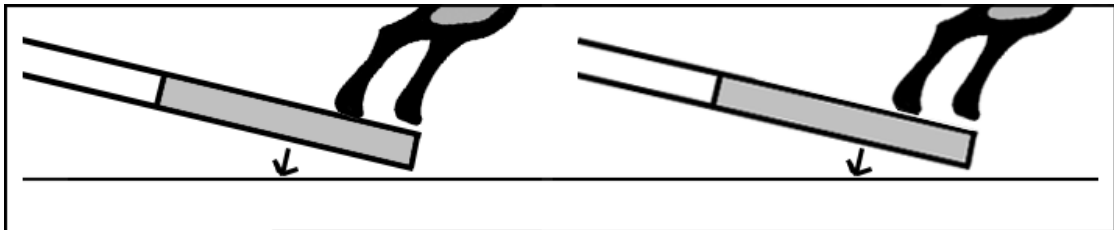

Left: The see-saw just before touching the ground: the dog pushes the see-saw to the ground. However, there is still contact with the hind paws when the see-saw touches the ground = OK.

Right: This situation is more difficult to judge: the dog pushes the see-saw down as well, but you cannot be sure if the see-saw is actually touching the ground before the last paw loses contact with the see-saw. In this case, give the dog the benefit of the doubt.

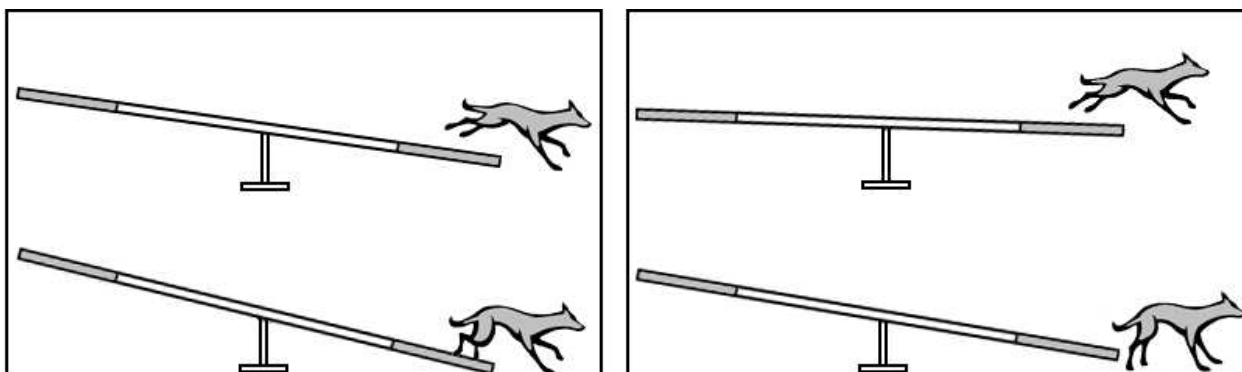

Left: the dog starts to leave too early but lands two paws on, two paws off = OK

Right: the dog starts to leave too early and lands on the floor = F

14.4 Second judge at the upside of the dog-walk

If an assistant judge is acting in the course, he is not allowed to judge anything else but the up contact of the dog-walk and, if needed, the immediate area around the upside of the dog-walk while the dog is approaching the dog-walk in the running order.

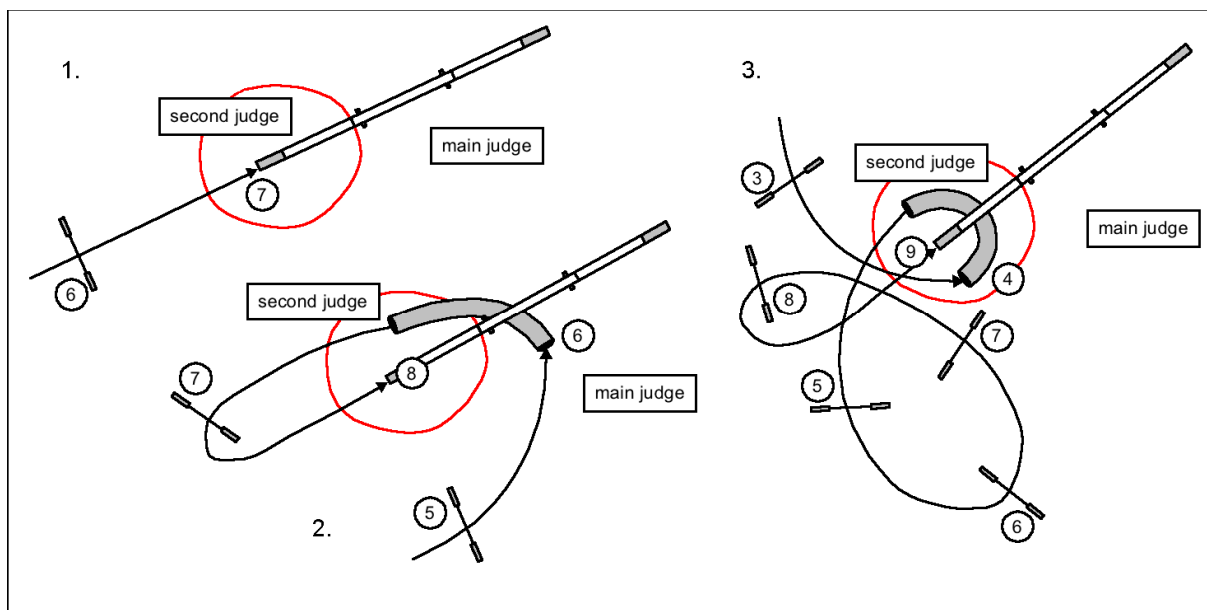

Both judges have to be clear on who is judging what:

1. The area where the assistant judge is responsible for judging the contact area, touching of the dog/obstacle and refusals – this until the dog is on the horizontal plank with all four paws.
2. In this situation, the assistant is also watching the exit of obstacle 6 (tunnel - including eliminating the dog if it should go into the exit of the tunnel instead of obstacle 8, dog-walk)
3. If the tunnel is positioned in a U-shape, as in example 3, the assistant judge should then also judge the entry of the tunnel as well as the previously mentioned points.

15. Other

15.1 Eliminations

Description of “leaving the ring”:

- Dog found something outside the ring which is obviously more attractive for him than to stay inside
- Handler tried several times to call his dog, but without success

15.2 Refusals

A dog that is faulted with a refusal for standing still on the course (not on an obstacle) should not be faulted with another refusal until it has taken at least another step.

15.3 Start sequence

If the dog refuses the first obstacle, the handler should correct the refusal in a fluent movement.

If the handler restarts or stops the dog's natural movement to restart the dog = E

15.4 Re-run

When a rerun is necessary, the following points should be noted:

- The faults incurred before the dog was stopped will count.
- Judging will recommence at the point where the dog was stopped.
- The course should be done in the correct sequence and to the best of the competitor's ability.
- The judge can still decide to fault the dog if he feels that the handler isn't doing the rerun to the best of his ability.

The English version of these Guidelines is the authentic one.

The changes in bold and italic were approved by the FCI General Committee (online meeting) on September 3-4, 2020.

They will be applied from April 1st, 2021.

The changes in bold and blue characters were approved by the FCI General Committee during its online meeting on September 4, 2020.